

# **LECTURE NOTES**

**ON**

# **SOFTWARE ENGINEERING**

**B.Tech IV Semester**

**Ms. B DHANALAXMI**

**Assistant Professor**

**Mr. A.PRAVEEN**

**Assistant Professor**



**INFORMATION TECHNOLOGY**

**INSTITUTE OF AERONAUTICAL ENGINEERING**

**(Autonomous)**

**DUNDIGAL, HYDERABAD - 500 043**

## SYLLUBUS

<b>IV Semester: IT   V Semester: CSE</b>								
Course Code	Category	Hours / Week			Credits	Maximum Marks		
ACS008	Core	L	T	P	C	CIA	SEE	Total
		3	1	-	4	30	70	100
<b>Contact Classes: 45</b>		<b>Tutorial Classes: 15</b>		<b>Practical Classes: Nil</b>		<b>Total Classes: 60</b>		
<b>OBJECTIVES:</b>								
<b>The course should enable the students to:</b>								
I. Learn how to elicitate requirements and develop software life cycles.								
II. Understand the design considerations for enterprise integration and deployment.								
III. Analyze quality assurance techniques and testing methodologies.								
IV. Prepare a project plan for a software project that includes estimates of size and effort, a schedule, resource allocation, configuration control, and project risk.								
<b>UNIT-I</b>	<b>SOFTWARE PROCESS AND PROJECT MANAGEMENT</b>						<b>Classes: 08</b>	
Introduction to software engineering, software process, perspective and specialized process models; Software project management: Estimation: LOC and FP based estimation, COCOMO model; Project scheduling: Scheduling, earned value analysis, risk management.								
<b>UNIT-II</b>	<b>REQUIREMENTS ANALYSIS AND SPECIFICATION</b>						<b>Classes: 09</b>	
Software requirements: Functional and nonfunctional, user requirements, system requirements, software requirements document; Requirement engineering process: Feasibility studies, requirements elicitation and analysis, requirements validation, requirements management; Classical analysis: Structured system analysis, petri nets, data dictionary.								
<b>UNIT-III</b>	<b>SOFTWARE DESIGN</b>						<b>Classes: 09</b>	
Design process: Design concepts, design model, design heuristic, architectural design architectural styles, architectural design, and architectural mapping using data flow.								
User interface design: Interface analysis, interface design; Component level design: Designing class based components, traditional components.								
<b>UNIT-IV</b>	<b>TESTING AND IMPLEMENTATION</b>						<b>Classes: 10</b>	
Software testing fundamentals: Internal and external views of testing, white box testing, basis path testing, control structure testing, black box testing, regression testing, unit testing, integration testing, validation testing, system testing and debugging; Software implementation techniques: Coding practices, refactoring.								
<b>UNIT-V</b>	<b>PROJECT MANAGEMENT</b>						<b>Classes: 09</b>	
Estimation: FP based, LOC based, make/buy decision; COCOMO II: Planning, project plan, planning process, RFP risk management, identification, projection; RMMM: Scheduling and tracking, relationship between people and effort, task set and network, scheduling; EVA: Process and project metrics.								

**Text Books:**

1. Roger S. Pressman, “Software Engineering – A Practitioner’s Approach”, McGraw-Hill International Edition, 7<sup>th</sup> Edition, 2010.
2. Ian Somerville, “Software Engineering” Pearson Education Asia, 9<sup>th</sup> Edition, 2011

**Reference Books:**

1. Rajib Mall, “Fundamentals of Software Engineering”, PHI Learning Private Limited, 3<sup>rd</sup> Edition, 2009.
2. Pankaj Jalote, “Software Engineering, A Precise Approach”, Wiley India, 1<sup>st</sup> Edition, 2010.

**Web References:**

1. <http://www.softwareengineerinsider.com/articles/what-is-software-engineering.html>
2. <https://www.udacity.com/courses/software-engineering>
3. [http://www.tutorialspoint.com/software\\_engineering](http://www.tutorialspoint.com/software_engineering)
4. [http://computingcareers.acm.org/?page\\_id=12](http://computingcareers.acm.org/?page_id=12)
5. [http://en.wikibooks.org/wiki/Introduction\\_to\\_Software\\_Engineering](http://en.wikibooks.org/wiki/Introduction_to_Software_Engineering)

**E-Text Books:**

1. [http://www.acadmix.com/eBooks\\_Download](http://www.acadmix.com/eBooks_Download)
2. <http://www.freetechbooks.com/software-engineering-f15.html>

**UNIT- I: Software process and project management: Introduction to software engineering, software process, perspective and specialized process models; Software project management: Estimation: LOC and FP based estimation, COCOMO model; Project scheduling: Scheduling, earned value analysis, risk management.**

### **Introduction to software engineering**

**What is Software?**

- **The product that software professionals build and then support over the long term.**
- **Software encompasses:**
  - I. Instructions (computer programs) that when executed provide desired features, function, and performance;**
  - II. Data structures that enable the programs to adequately store and manipulate information and**
  - III. Documentation that describes the operation and use of the programs.**

### **Software products**

- **Generic products**
  - **Stand-alone systems that are marketed and sold to any customer**
- **Who wishes to buy them?**
  - **Examples – PC software such as editing, graphics programs, project management tools; CAD software; software for specific markets such as appointments systems for dentists.**
  -
- **Customized products**
  - **Software that is commissioned by a specific customer to meet their own needs.**
  - **Examples – embedded control systems, air traffic control software, traffic monitoring systems.**

### **Why Software is Important?**

- **The economies of ALL developed nations are dependent on software.**
- **More and more systems are software controlled (transportation, medical, telecommunications, military, industrial, entertainment, etc...)**
- **Software engineering is concerned with theories, methods and tools for professional software development.**
- **Expenditure on software represents a significant fraction of Gross national product (GNP) in all developed countries.**

## **Features of Software**

- Its characteristics that make it different from other things human being build.
- Features of such logical system:
- Software is developed or engineered; it is not manufactured in the classical sense which has quality problem.
- Software doesn't "wear out." but it deteriorates (due to change). Hardware has bathtub curve of failure rate ( high failure rate in the beginning, then drop to steady state, then cumulative effects of dust, vibration, abuse occurs).
- Although the industry is moving toward component-based construction (e.g. standard screws and off-the-shelf integrated circuits), most software continues to be custom-built. Modern reusable components encapsulate data and processing into software parts to be reused by different programs. E.g. graphical user interface, window, pull-down menus in library etc.

## **Software Applications**

- I. System software: such as compilers, editors, file management utilities
- II. Application software: stand-alone programs for specific needs.
- III. Engineering/scientific software: Characterized by “number crunching” algorithms. such as automotive stress analysis, molecular biology, orbital dynamics etc
- IV. Embedded software resides within a product or system. (key pad control of a microwave oven, digital function of dashboard display in a car)
- V. Product-line software focus on a limited marketplace to address mass consumer market. (word processing, graphics, database management)
- VI. WebApps (Web applications) network centric software. As web 2.0 emerges, more sophisticated computing environments is supported integrated with remote database and business applications.
- VII. AI software uses non-numerical algorithm to solve complex problem. Robotics, expert system, pattern recognition game playing

## **Software Engineering Definition**

### **The seminal definition:**

[Software engineering is] the establishment and use of sound engineering principles in order to obtain economically software that is reliable and works efficiently on real machines.

### **The IEEE definition:**

**Software Engineering:**

- (1) The application of a systematic, disciplined, quantifiable approach to the development, operation, and maintenance of software; that is, the application of engineering to software.
- (2) The study of approaches as in (1).

## Software Engineering A Layered Technology

- Any engineering approach must rest on organizational commitment to quality which fosters a continuous process improvement culture.
- Process layer as the foundation defines a framework with activities for effective delivery of software engineering technology. Establish the context where products (model, data, report, and forms) are produced, milestones are established, quality is ensured and change is managed.
- Method provides technical how-to's for building software. It encompasses many tasks including communication, requirement analysis, design modeling, program construction, testing and support.
- Tools provide automated or semi-automated support for the process and methods



## Software Process

- A process is a collection of activities, actions and tasks that are performed when some work product is to be created. It is not a rigid prescription for how to build computer software. Rather, it is an adaptable approach that enables the people doing the work to pick and choose the appropriate set of work actions and tasks.
- Purpose of process is to deliver software in a timely manner and with sufficient quality to satisfy those who have sponsored its creation and those who will use it.

## Five Activities of a Generic Process Framework

- **Communication:** communicate with customer to understand objectives and gather requirements.
- **Planning:** creates a “map” defines the work by describing the tasks, risks and resources, work products and work schedule.
- **Modeling:** Create a “sketch”, what it looks like architecturally, how the constituent parts fit together and other characteristics.
- **Construction:** code generation and the testing.
- **Deployment:** Delivered to the customer who evaluates the products and provides feedback based on the evaluation.

These five framework activities can be used to all software development regardless of the application domain, size of the project, complexity of the efforts etc, though the details will be different in each case.

For many software projects, these framework activities are applied iteratively as a project progresses. Each iteration produces a software increment that provides a subset of overall software features and functionality.

### Umbrella Activities

Complement the five process framework activities and help team manage and control progress, quality, change, and risk.

- **Software project tracking and control:** assess progress against the plan and take actions to maintain the schedule.
- **Risk management:** assesses risks that may affect the outcome and quality.
- **Software quality assurance:** defines and conduct activities to ensure quality.
- **Technical reviews:** assesses work products to uncover and remove errors before going to the next activity.
- **Measurement:** define and collects process, project, and product measures to ensure stakeholder's needs are met.
- **Software configuration management:** manage the effects of change throughout the software process.
- **Reusability management:** defines criteria for work product reuse and establishes mechanism to achieve reusable components.
- **Work product preparation and production:** create work products such as models, documents, logs, forms and lists.

### Adapting a Process Model

The process should be agile and adaptable to problems. Process adopted for one project might be significantly different than a process adopted from another project. (to the problem, the project, the team, organizational culture). Among the differences are:

- the overall flow of activities, actions, and tasks and the interdependencies among them
- the degree to which actions and tasks are defined within each framework activity
- the degree to which work products are identified and required
- the manner which quality assurance activities are applied
- the manner in which project tracking and control activities are applied
- the overall degree of detail and rigor with which the process is described
- the degree to which the customer and other stakeholders are involved with the project
- the level of autonomy given to the software team
- the degree to which team organization and roles are prescribed

## Software Process: A Generic Process Model

- A framework for the activities, actions, and tasks that are required to build high-quality software.
- SP defines the approach that is taken as software is engineered.
- Is not equal to software engineering, which also encompasses technologies that populate the process – technical methods and automated tools.

### 1. A Generic process model

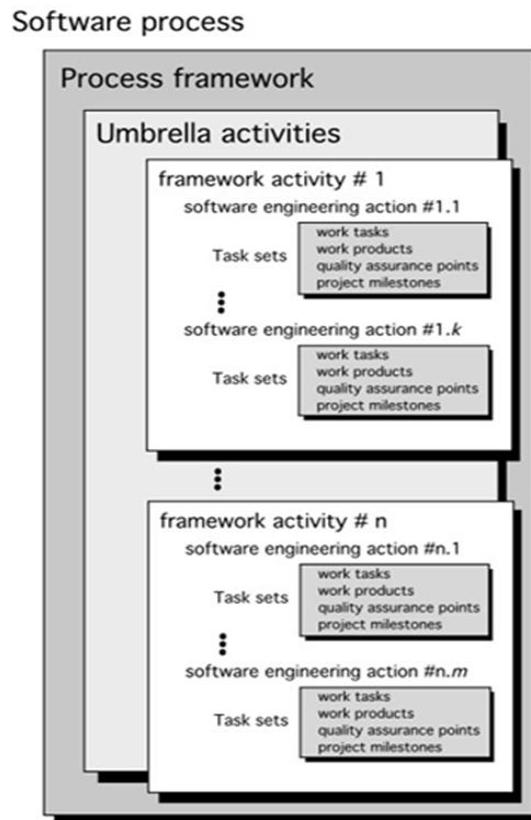

A generic process framework for software engineering defines five framework activities- communication, planning, modeling, construction, and deployment. In addition, a set of umbrella activities- project tracking and control, risk management, quality assurance, configuration management, technical reviews, and others are applied throughout the process. Next question is: how the framework activities and the actions and tasks that occur within each activity are organized with respect to sequence and time? See the process flow for answer.

### **Process Flow**

1. Linear process flow executes each of the five activities in sequence.
2. An iterative process flow repeats one or more of the activities before proceeding to the next.



3. An evolutionary process flow executes the activities in a circular manner. Each circuit leads to a more complete version of the software.
4. A parallel process flow executes one or more activities in parallel with other activities (modeling for one aspect of the software in parallel with construction of another aspect of the software).

## 2. Identifying a Task Set

Before you can proceed with the process model, a key question: what actions are appropriate for a framework activity given the nature of the problem, the characteristics of the people and the stakeholders?

- A task set defines the actual work to be done to accomplish the objectives of a software engineering action.
- A list of the task to be accomplished
- A list of the work products to be produced
- A list of the quality assurance filters to be applied

### Example of a Task Set for Elicitation

The task sets for Requirements gathering action for a simple project may include:

1. Make a list of stakeholders for the project.
2. Invite all stakeholders to an informal meeting.
3. Ask each stakeholder to make a list of features and functions required.
4. Discuss requirements and build a final list.
5. Prioritize requirements.
6. Note areas of uncertainty.

## 3. Process Patterns

- A *process pattern*
    - describes a process-related problem that is encountered during software engineering work,
    - identifies the environment in which the problem has been encountered, and
    - suggests one or more proven solutions to the problem.
  - Stated in more general terms, a process pattern provides you with a *template* [Amb98]—a consistent method for describing problem solutions within the context of the software process.
1. Problems and solutions associated with a complete process model (e.g. prototyping).
  2. Problems and solutions associated with a framework activity (e.g. planning) or
  3. An action with a framework activity (e.g. project estimating).

## Process Pattern Types

- *Stage patterns*—defines a problem associated with a framework activity for the process. It includes multiple task patterns as well. For example, Establishing Communication would incorporate the task pattern Requirements Gathering and others.
- *Task patterns*—defines a problem associated with a software engineering action or work task and relevant to successful software engineering practice
- *Phase patterns*—define the sequence of framework activities that occur with the process, even when the overall flow of activities is iterative in nature. Example includes Spiral Model or Prototyping.

## An Example of Process Pattern

- Describes an approach that may be applicable when stakeholders have a general idea of what must be done but are unsure of specific software requirements.
- **Pattern name.** Requirement Unclear
- **Intent.** This pattern describes an approach for building a model that can be assessed iteratively by stakeholders in an effort to identify or solidify software requirements.
- **Type.** Phase pattern
- **Initial context.** Conditions must be met (1) stakeholders have been identified; (2) a mode of communication between stakeholders and the software team has been established; (3) the overriding software problem to be solved has been identified by stakeholders ; (4) an initial understanding of project scope, basic business requirements and project constraints has been developed.
- **Problem.** Requirements are hazy or nonexistent. Stakeholders are unsure of what they want.
- **Solution.** A description of the prototyping process would be presented here.
- **Resulting context.** A software prototype that identifies basic requirements. (modes of interaction, computational features, processing functions) is approved by stakeholders. Following this, 1. This prototype may evolve through a series of increments to become the production software or 2. the prototype may be discarded.
- **Related patterns.** Customer Communication, Iterative Design, Iterative Development, Customer Assessment, Requirement Extraction.

## Process Assessment and Improvement

- The existence of a software process is no guarantee that software will be delivered on time, that it will meet the customer's needs, or that it will exhibit the technical characteristics that will lead to long-term quality characteristics.
- A number of different approaches to software process assessment and improvement have been proposed over the past few decades:
- **Standard CMMI Assessment Method for Process Improvement (SCAMPI)**—provides a five-step process assessment model that incorporates five phases: initiating, diagnosing, establishing, acting, and learning. The SCAMPI method uses the SEI CMMI as the basis for assessment [SEI00].
- **CMM-Based Appraisal for Internal Process Improvement (CBA IPI)**— provides a diagnostic technique for assessing the relative maturity of a software organization; uses the SEI CMM as the basis for the assessment [Dun01].

- **SPICE (ISO/IEC15504)**—a standard that defines a set of requirements for software process assessment. The intent of the standard is to assist organizations in developing an objective evaluation of the efficacy of any defined software process [ISO08].
- **ISO 9001:2000 for Software**—a generic standard that applies to any organization that wants to improve the overall quality of the products, systems, or services that it provides. Therefore, the standard is directly applicable to software organizations and companies [Ant06].

## Prescriptive Process Models

- **Classic Process Models**
  - Waterfall Model (Linear Sequential Model)
- **Incremental Process Models**
  - Incremental Model
- **Evolutionary Software Process Models**
  - Prototyping
  - Spiral Model
  - Concurrent Development Model

### 1. Classic Process Models - Waterfall Model (Linear Sequential Model)

- The waterfall model, sometimes called the classic life cycle.
- It is the oldest paradigm for Software Engineering. When requirements are well defined and reasonably stable, it leads to a linear fashion
- The waterfall model, sometimes called the classic life cycle, suggests a systematic,
- sequential approach to software development that begins with customer specification of requirements and progresses through planning, modeling, construction, and deployment, culminating in ongoing support of the completed software.

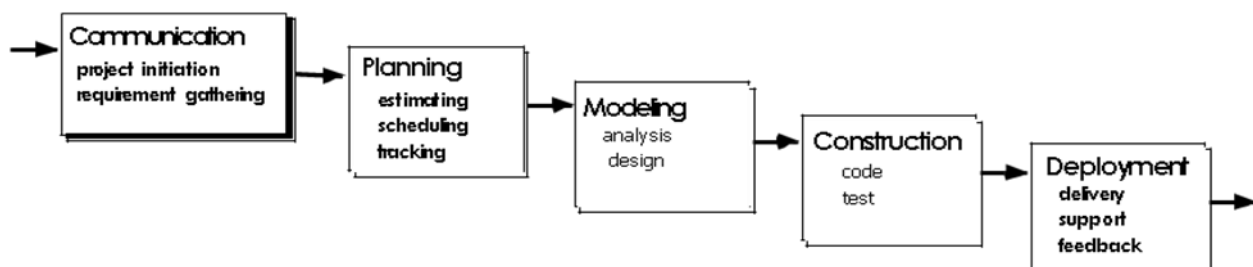

A variation of waterfall model depicts the relationship of quality assurance actions to the actions associated with communication, modeling and early code construction activates.

Team first moves down the left side of the V to refine the problem requirements. Once code is generated, the team moves up the right side of the V, performing a series of tests that validate each of the models created as the team moved down the left side.

The V-model provides a way of visualizing how verification and validation actions are applied to earlier engineering work.

### The V Model

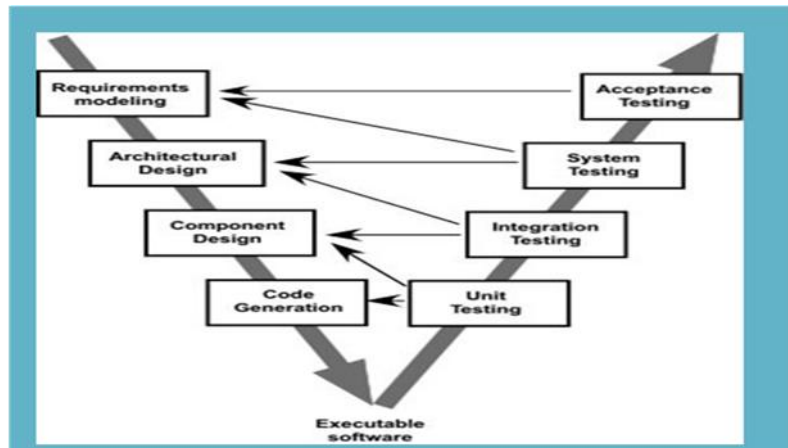

**The problems that are sometimes encountered when the waterfall model is applied are:**

- Real projects rarely follow the sequential flow that the model proposes. Although the linear model can accommodate iteration, it does so indirectly. As a result, changes can cause confusion as the project team proceeds.
- It is often difficult for the customer to state all requirements explicitly. The waterfall model requires this and has difficulty accommodating the natural uncertainty that exists at the beginning of many projects.
- The customer must have patience. A working version of the program(s) will not be available until late in the project time span. A major blunder, if undetected until the working program is reviewed, can be disastrous.

### **2. Incremental Process Models - Incremental Model**

- When initial requirements are reasonably well defined, but the overall scope of the development effort precludes a purely linear process. A compelling need to expand a limited set of new functions to a later system release.
- It combines elements of linear and parallel process flows. Each linear sequence produces deliverable increments of the software.
- The first increment is often a core product with many supplementary features. Users use it and evaluate it with more modifications to better meet the needs.
- The incremental process model focuses on the delivery of an operational product with each increment. Early increments are stripped-down versions of the final product, but they do

provide capability that serves the user and also provide a platform for evaluation by the user.

- Incremental development is particularly useful when staffing is unavailable for a complete implementation by the business deadline that has been established for the project

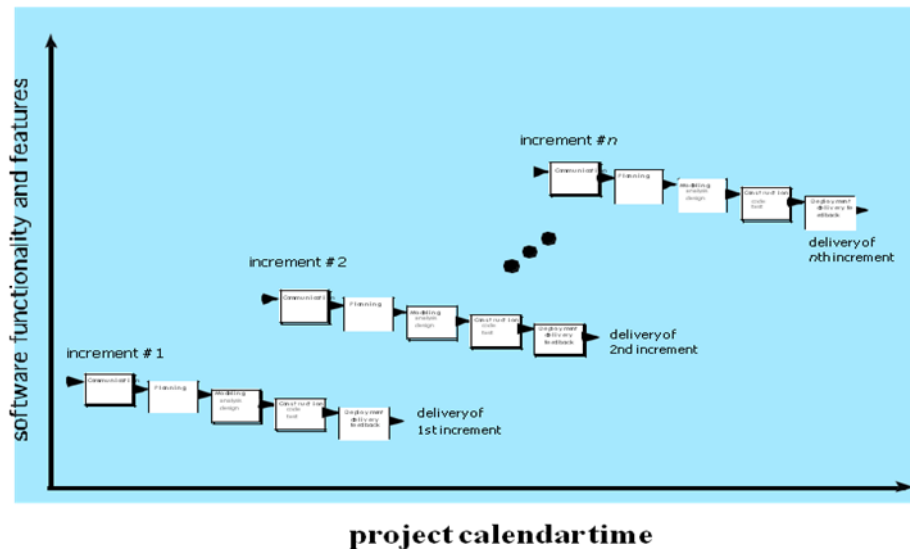

### 3. Evolutionary Software Process Models

- Prototyping
  - Spiral Model
  - Concurrent Development Model
- 
- Software system evolves over time as requirements often change as development proceeds. Thus, a straight line to a complete end product is not possible. However, a limited version must be delivered to meet competitive pressure.
  - Usually a set of core product or system requirements is well understood, but the details and extension have yet to be defined.
  - You need a process model that has been explicitly designed to accommodate a product that evolved over time.
  - It is iterative that enables you to develop increasingly more complete version of the software.
  - Two types are introduced, namely Prototyping and Spiral models.

### Evolutionary Models: Prototyping

- **When to use:** Customer defines a set of general objectives but does not identify detailed requirements for functions and features. or Developer may be unsure of the efficiency of an algorithm, the form that human computer interaction should take.
- **What step:** Begins with communication by meeting with stakeholders to define the objective, identify whatever requirements are known, outline areas where further definition is mandatory. A quick plan for prototyping and modeling (quick design) occur. Quick design focuses on a representation of those aspects the software that will be visible to end users. (interface and output). Design leads to the construction of a prototype which will be deployed and evaluated. Stakeholder's comments will be used to refine requirements.
- Both stakeholders and software engineers like the prototyping paradigm. Users get a feel for the actual system, and developers get to build something immediately. However, engineers may make compromises in order to get a prototype working quickly. The less-than-ideal choice may be adopted forever after you get used to it.

### Prototyping can be problematic for the following reasons:

- Stakeholders see what appears to be a working version of the software, unaware that the prototype is held together haphazardly, unaware that in the rush to get it working you hasn't considered overall software quality or long-term maintainability.
- As a software engineer, you often make implementation compromises in order to get a prototype working quickly.
- An inappropriate operating system or programming language may be used simply because it is available and known;
- An inefficient algorithm may be implemented simply to demonstrate capability. After a time, you may become comfortable with these choices and forget all the reasons why they were inappropriate. The less-than-ideal choice has now become an integral part of the system

### Evolutionary Models: The Spiral

- It couples the iterative nature of prototyping with the controlled and systematic aspects of the waterfall model and is a risk-driven process model generator that is used to guide multi-stakeholder concurrent engineering of software intensive systems.
- Two main distinguishing features: one is cyclic approach for incrementally growing a system's degree of definition and implementation while decreasing its degree of risk. The other is a set of anchor point milestones for ensuring stakeholder commitment to feasible and mutually satisfactory system solutions.
- A series of evolutionary releases are delivered. During the early iterations, the release might be a model or prototype. During later iterations, increasingly more complete version of the engineered system are produced.
- The first circuit in the clockwise direction might result in the product specification; subsequent passes around the spiral might be used to develop a prototype and then progressively more sophisticated versions of the software.

- Each pass results in adjustments to the project plan. Cost and schedule are adjusted based on feedback. Also, the number of iterations will be adjusted by project manager.
- Good to develop large-scale system as software evolves as the process progresses and risk should be understood and properly reacted to. Prototyping is used to reduce risk.
- However, it may be difficult to convince customers that it is controllable as it demands considerable risk assessment expertise.

### Concurrent Model

- Allow a software team to represent iterative and concurrent elements of any of the process models. For example, the modeling activity defined for the spiral model is accomplished by invoking one or more of the following actions: prototyping, analysis and design.
- The Figure shows modeling may be in any one of the states at any given time. For example, communication activity has completed its first iteration and in the awaiting changes state. The modeling activity was in inactive state, now makes a transition into the under development state. If customer indicates changes in requirements, the modeling activity moves from the under development state into the awaiting changes state.
- Concurrent modeling is applicable to all types of software development and provides an accurate picture of the current state of a project. Rather than confining software engineering activities, actions and tasks to a sequence of events, it defines a process network. Each activity, action or task on the network exists simultaneously with other activities, actions or tasks. Events generated at one point trigger transitions among the state.

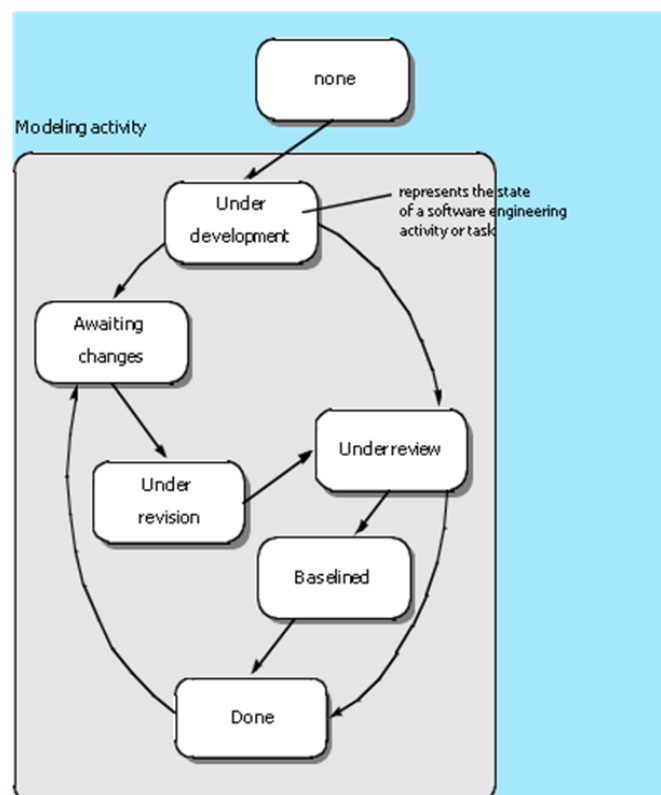

## **Specialized Process Models**

Specialized process models take on many of the characteristics of one or more of the traditional models. However, these models tend to be applied when a specialized or narrowly defined software engineering approach is chosen.

- **Component-Based Development**
- **The Formal Methods Model**
- **Aspect-Oriented Software Development**

### **1. Component-Based Development:**

Commercial off-the-shelf (COTS) software components, developed by vendors who offer them as products, provide targeted functionality with well-defined interfaces that enable the component to be integrated into the software that is to be built.

These components can be as either conventional software modules or object-oriented packages or packages of classes

#### **Steps involved in CBS are**

- Available component-based products are researched and evaluated for the application domain in question.
- Component Integration issues are considered.
- A software architecture is designed to accommodate the components
- Components are integrated into the architecture
- Comprehensive testing is conducted to ensure proper functionality
- Component-based development model leads to software reuse and reusability helps software engineers with a number of measurable benefits
- Component-based development leads to a 70 percent reduction in development cycle time, 84 percent reduction in project cost and productivity index of 26.2 compared to an industry norm of 16.9

### **2. Formal Methods Model**

- Formal methods model encompasses a set of activities that leads to formal mathematical specification of computer software
- They enable software engineers to specify, develop and verify a computer-based system by applying a rigorous mathematical notation
- Development of formal models is quite time consuming and expensive
- Extensive training is needed in applying formal methods
- Difficult to use the model as a communication mechanism for technically unsophisticated customers

### **3. Aspect-oriented Software Development**

- The aspect-oriented approach is based on the principle of identifying common program code within certain aspects and placing the common procedures outside the main business logic



- The process of aspect orientation and software development may include modeling, design, programming, reverse-engineering and re-engineering;
- The domain of AOSD includes applications, components and databases;
- Interaction with and integration into other paradigms is carried out with the help of frameworks, generators, program languages and architecture-description languages (ADL).

### The Unified process, personal and team process models

- The Unified Process is an iterative and incremental development process. Unified Process divides the project into four phases
  1. Inception
  2. Elaboration
  3. Construction
  4. Transition
- The Inception, Elaboration, Construction and Transition phases are divided into a series of time boxed iterations. (The Inception phase may also be divided into iterations for a large project.)
- Each iteration results in an *increment*, which is a release of the system that contains added or improved functionality compared with the previous release.
- Although most iterations will include work in most of the process disciplines (*e.g.* Requirements, Design, Implementation, Testing) the relative effort and emphasis will change over the course of the project.
- Risk Focused
  - The Unified Process requires the project team to focus on addressing the most critical risks early in the project life cycle. The deliverables of each iteration, especially in the Elaboration phase, must be selected in order to ensure that the greatest risks are addressed first. Risk Focused
- **Inception Phase**
  - Inception is the smallest phase in the project, and ideally it should be quite short. If the Inception Phase is long then it is usually an indication of excessive up-front specification, which is contrary to the spirit of the Unified Process.
  - The following are typical goals for the Inception phase.
    - Establish a justification or business case for the project
    - Establish the project scope and boundary conditions
    - Outline the use cases and key requirements that will drive the design tradeoffs
    - Outline one or more candidate architectures
    - Identify risks
    - Prepare a preliminary project schedule and cost estimate
  - The Lifecycle Objective Milestone marks the end of the Inception phase.
- **Elaboration Phase**
  - During the Elaboration phase the project team is expected to capture a majority of the system requirements. The primary goals of Elaboration are to address known risk factors and to establish and validate the system architecture.
  - Common processes undertaken in this phase include the creation of use case diagrams, conceptual diagrams (class diagrams with only basic notation) and package diagrams (architectural diagrams).

- The architecture is validated primarily through the implementation of an Executable Architectural Baseline. This is a partial implementation of the system which includes the core, most architecturally significant, components. It is built in a series of small, timeboxed iterations.
  - By the end of the Elaboration phase the system architecture must have stabilized and the executable architecture baseline must demonstrate that the architecture will support the key system functionality and exhibit the right behavior in terms of performance, scalability and cost.
  - The final Elaboration phase deliverable is a plan (including cost and schedule estimates) for the Construction phase. At this point the plan should be accurate and credible, since it should be based on the Elaboration phase experience and since significant risk factors should have been addressed during the Elaboration phase.
  - The Lifecycle Architecture Milestone marks the end of the Elaboration phase.
- **Construction Phase**
    - Construction is the largest phase in the project. In this phase the remainder of the system is built on the foundation laid in Elaboration. System features are implemented in a series of short, timeboxed iterations. Each iteration results in an executable release of the software. It is customary to write full text use cases during the construction phase and each one becomes the start of a new iteration.
    - Common UML (Unified Modeling Language) diagrams used during this phase include Activity, Sequence, Collaboration, State (Transition) and Interaction Overview diagrams.
    - The Initial Operational Capability Milestone marks the end of the Construction phase.
- **Transition Phase**
    - The final project phase is Transition. In this phase the system is deployed to the target users. Feedback received from an initial release (or initial releases) may result in further refinements to be incorporated over the course of several Transition phase iterations. The Transition phase also includes system conversions and user training.
    - The Product Release Milestone marks the end of the Transition phase.

### **Advantages of UP Software Development**

- This is a complete methodology in itself with an emphasis on accurate documentation
- It is proactively able to resolve the project risks associated with the client's evolving requirements requiring careful change request management
- Less time is required for integration as the process of integration goes on throughout the software development life cycle.
- The development time required is less due to reuse of components.

### **Disadvantages of RUP Software Development**

- The team members need to be expert in their field to develop a software under this methodology.
- On cutting edge projects which utilise new technology, the reuse of components will not be possible. Hence the time saving one could have made will be impossible to fulfill.

- Integration throughout the process of software development, in theory sounds a good thing. But on particularly big projects with multiple development streams it will only add to the confusion and cause more issues during the stages of testing

### Personal and Team process models

- The best software process is one that is close to the people who will be doing the work. The PSP model defines five framework activities.

#### **1. Personal Software Process (PSP)**

**Planning.** This activity isolates requirements and develops both size and resource estimates. In addition, a defect estimate is made. All metrics are recorded on worksheets or templates. Finally, development tasks are identified and a project schedule is created.

**High-level design.** External specifications for each component to be constructed are developed and a component design is created. Prototypes are built when uncertainty exists. All issues are recorded and tracked.

**High-level design review.** Formal verification methods (Chapter 21) are applied to uncover errors in the design. Metrics are maintained for all important tasks and work results.

**Development.** The component-level design is refined and reviewed. Code is generated, reviewed, compiled, and tested. Metrics are maintained for all important tasks and work results.

**Postmortem.** Using the measures and metrics collected, the effectiveness of the process is determined. Measures and metrics should provide guidance for modifying the process to improve its effectiveness.

#### **2. Team Software Process (TSP):** The goal of TSP is to build a “self directed” project team that organizes itself to produce high-quality software. TSP objectives are,

- Build self-directed teams that plan and track their work, establish goals, and own their processes and plans. These can be pure software teams or integrated product teams (IPTs) of 3 to about 20 engineers.
- Show managers how to coach and motivate their teams and how to help them sustain peak performance.
- Accelerate software process improvement by making CMM23 Level 5 behavior normal and expected.
- Provide improvement guidance to high-maturity organizations.
- Facilitate university teaching of industrial-grade team skills.

## Software project management: Estimation

Estimation is attempt to determine how much money, effort, resources & time it will take to build a specific software based system or project.

Estimation involves answering the following questions:

1. How much effort is required to complete each activity?
2. How much calendar time is needed to complete each activity?
3. What is the total cost of each activity?

Project cost estimation and project scheduling are normally carried out together.

The costs of development are primarily the costs of the effort involved, so the effort computation is used in both the cost and the schedule estimate.

Do some cost estimation before detailed schedules are drawn up.

These initial estimates may be used to establish a budget for the project or to set a price for the software for a customer.

There are three parameters involved in computing the total cost of a software development project:

- Hardware and software costs including maintenance
- Travel and training costs
- Effort costs (the costs of paying software engineers).

The following costs are all part of the total effort cost:

1. Costs of providing, heating and lighting office space
2. Costs of support staff such as accountants, administrators, system managers, cleaners and technicians
3. Costs of networking and communications
4. Costs of central facilities such as a library or recreational facilities
5. Costs of Social Security and employee benefits such as pensions and health insurance.

## Factors affecting software pricing

Factor	Description
Market opportunity	A development organisation may quote a low price because it wishes to move into a new segment of the software market. Accepting a low profit on one project may give the organisation the opportunity to make a greater profit later. The experience gained may also help it develop new products.
Cost estimate uncertainty	If an organisation is unsure of its cost estimate, it may increase its price by some contingency over and above its normal profit.
Contractual terms	A customer may be willing to allow the developer to retain ownership of the source code and reuse it in other projects. The price charged may then be less than if the software source code is handed over to the customer.
Requirements volatility	If the requirements are likely to change, an organisation may lower its price to win a contract. After the contract is awarded, high prices can be charged for changes to the requirements.
Financial health	Developers in financial difficulty may lower their price to gain a contract. It is better to make a smaller than normal profit or break even than to go out of business.

## Introduction about LOC and FP based estimation

### Function Points:

- **STEP 1:** measure size in terms of the amount of functionality in a system. Function points are computed by first calculating an *unadjusted function point count* (UFC). Counts are made for the following categories
  - *External inputs* – those items provided by the user that describe distinct application-oriented data (such as file names and menu selections)
  - *External outputs* – those items provided to the user that generate distinct application-oriented data (such as reports and messages, rather than the individual components of these)
  - *External inquiries* – interactive inputs requiring a response
  - *External files* – machine-readable interfaces to other systems
  - *Internal files* – logical master files in the system
- **STEP 2:** Multiply each number by a weight factor, according to complexity (simple, average or complex) of the parameter, associated with that number. The value is given by a table:

Parameter	simple	average	complex
users inputs	3	4	6
users outputs	4	5	7
users requests	3	4	6
files	7	10	15
external interfaces	5	7	10

- **STEP 3:** Calculate the total UFP (Unadjusted Function Points)
- **STEP 4:** Calculate the total TCF (Technical Complexity Factor) by giving a value between 0 and 5 according to the importance of the following points:
  - **STEP 5:** Sum the resulting numbers too obtain DI (degree of influence)
  - **STEP 6:** TCF (Technical Complexity Factor) by given by the formula
    - $TCF=0.65+0.01*DI$
  - **STEP 6:** Function Points are by given by the formula
    - $FP=UFP*TCF$

### Relation between LOC and FP

- $LOC = Language\ Factor * FP$
- where
  - LOC (Lines of Code)
  - FP (Function Points)

The Basic COCOMO model computes effort as a function of program size. The Basic COCOMO equation is:

- $E = aKLOC^b$
- Effort for three modes of Basic COCOMO.

Mode	a	b
<i>Organic</i>	2.4	1.05
<i>Semi-detached</i>	3.0	1.12
<i>Embedded</i>	3.6	1.20

- The intermediate COCOMO model computes effort as a function of program size and a set of cost drivers. The Intermediate COCOMO equation is:
  - $E = aKLOC^b * EAF$
- Effort for three modes of intermediate COCOMO.

Mode	a	b
<i>Organic</i>	2.4	1.05
<i>Semi-detached</i>	3.0	1.12
<i>Embedded</i>	3.6	1.20

Total EAF = Product of the selected factors

Adjusted value of Effort: Adjusted Person Months:  
 $APM = (\text{Total EAF}) * PM$

A development process typically consists of the following stages:

- Requirements Analysis
- Design (High Level + Detailed)
- Implementation & Coding
- Testing (Unit + Integration)

#### Error Estimation

- Calculate the estimated number of errors in your design, i.e. total errors found in requirements, specifications, code, user manuals, and bad fixes:
  - Adjust the Function Point calculated in step1 $AFP = FP ** 1.25$ 
  - Use the following table for calculating error estimates

Error Type	Error / AFP
Requirements	1
Design	1.25
Implementation	1.75
Documentation	0.6
Due to Bug Fixes	0.4

### LOC based estimation

- Source lines of code (SLOC), also known as lines of code (LOC), is a software metric used to measure the size of a computer program by counting the number of lines in the text of the program's source code.
- SLOC is typically used to predict the amount of effort that will be required to develop a program, as well as to estimate programming productivity or maintainability once the software is produced.
- Lines used for commenting the code and header file are ignored.

### **Two major types of LOC:**

#### 1. Physical LOC

- Physical LOC is the count of lines in the text of the program's source code including comment lines.
- Blank lines are also included unless the lines of code in a section consists of more than 25% blank lines.

#### 2. Logical LOC

- Logical LOC attempts to measure the number of executable statements, but their specific definitions are tied to specific computer languages.
- Ex: Logical LOC measure for C-like programming languages is the number of statement-terminating semicolons (;)

### **The problems of lines of code (LOC)**

- Different languages lead to different lengths of code
- It is not clear how to count lines of code
- A report, screen, or GUI generator can generate thousands of lines of code in minutes
- Depending on the application, the complexity of code is different.

## COCOMO model

The software cost estimation provides:

- The vital link between the general concepts and techniques of economic analysis and the particular world of software engineering.
- Software cost estimation techniques also provides an essential part of the foundation for good software management.

## Cost of a project

- The cost in a project is due to:
  - due the requirements for software, hardware and human resources
  - the cost of software development is due to the human resources needed
  - most cost estimates are measured in *person-months (PM)*
  - the cost of the project depends on the nature and characteristics of the project, at any point, the accuracy of the estimate will depend on the amount of reliable information we have about the final product.

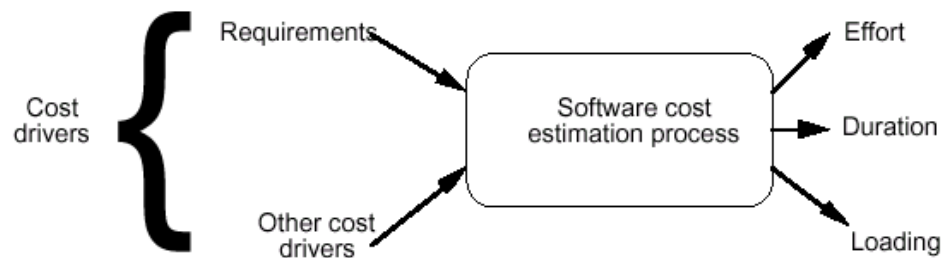

Figure 1. Classical view of software estimation process.

The Constructive Cost Model (COCOMO) is the most widely used software estimation model in the world. The COCOMO model predicts the effort and duration of a project based on inputs relating to the size of the resulting systems and a number of "cost drives" that affect productivity.

- **Effort Equation**
  - $PM = C * (KDSI)^n$  (person-months)
    - where PM = number of person-month (=152 working hours),
    - C = a constant,
    - KDSI = thousands of "delivered source instructions" (DSI) and
    - n = a constant.
- **Productivity equation**
  - $(DSI) / (PM)$ 
    - where PM = number of person-month (=152 working hours),
    - DSI = "delivered source instructions"
- **Schedule equation**
  - $TDEV = C * (PM)^n$  (months)
    - where TDEV = number of months estimated for software development.



- **Average Staffing Equation**
  - $(PM) / (TDEV) (FSP)$ 
    - where FSP means Full-time-equivalent Software Personnel.

**COCOMO is defined in terms of three different models:**

- **Basic model,**
  - **Intermediate model, and**
  - **Detailed model.**
- **The more complex models account for more factors that influence software projects, and make more accurate estimates.**
  - **The most important factors contributing to a project's duration and cost is the Development Mode**
    - **Organic Mode: The project is developed in a familiar, stable environment, and the product is similar to previously developed products. The product is relatively small, and requires little innovation.**
    - **Semidetached Mode: The project's characteristics are intermediate between Organic and Embedded.**
    - **Embedded Mode: The project is characterized by tight, inflexible constraints and interface requirements. An embedded mode project will require a great deal of innovation.**

<b>Feature</b>	<b>Organic</b>	<b>Semidetached</b>	<b>Embedded</b>
Organizational understanding of product and objectives	Thorough	Considerable	General
Experience in working with related software systems	Extensive	Considerable	Moderate
Need for software conformance with pre-established requirements	Basic	Considerable	Full
Need for software conformance with external interface specifications	Basic	Considerable	Full
Concurrent development of associated new hardware and operational procedures	Some	Moderate	Extensive
Need for innovative data processing architectures, algorithms	Minimal	Some	Considerable
Premium on early completion	Low	Medium	High
Product size range	<50 KDSI	<300KDSI	All

## **SCHEDULING:**

- ✓ You've selected an appropriate process model.
- ✓ You've identified the software engineering tasks that have to be performed.
- ✓ You estimated the amount of work and the number of people, you know the deadline, you've even considered the risks.
- ✓ Now it's time to connect the dots. That is, you have to create a network of software engineering tasks that will enable you to get the job done on time.
- ✓ Once the network is created, you have to assign responsibility for each task, make sure it gets done, and adapt the network as risks become reality.
- Why it's Important?
  - ✓ In order to build a complex system, many software engineering tasks occur in parallel.
  - ✓ The result of work performed during one task may have a profound effect on work to be conducted in another task.
  - ✓ These interdependencies are very difficult to understand without a schedule.
  - ✓ It's also virtually impossible to assess progress on a moderate or large software project without a detailed schedule
- What are the steps?
  - ✓ The software engineering tasks dictated by the software process model are refined for the functionality to be built.
  - ✓ Effort and duration are allocated to each task and a task network (also called an "activity network") is created in a manner that enables the software team to meet the delivery deadline established.

## **Basic Concept of Project Scheduling**

- ✓ An unrealistic deadline established by someone outside the software development group and forced on managers and practitioner's within the group.
- ✓ Changing customer requirements that are not reflected in schedule changes.
- ✓ An honest underestimate of the amount of effort and/or the number of resources that will be required to do the job.
- ✓ Predictable and/or unpredictable risks that were not considered when the project commenced.
- ✓ Technical difficulties that could not have been foreseen in advance.
- Why should we do when the management demands that we make a dead line I impossible?
  - ✓ Perform a detailed estimate using historical data from past projects.
  - ✓ Determine the estimated effort and duration for the project.
  - ✓ Using an incremental process model, develop a software engineering strategy that will deliver critical functionality by the imposed deadline, but delay other functionality until later. Document the plan.
  - ✓ Meet with the customer and (using the detailed estimate), explain why the imposed deadline is unrealistic.

## **Project Scheduling**

- I. Basic Principles**
- II. The Relationship Between People and Effort**
- III. Effort Distribution**

- Software project scheduling is an action that distributes estimated effort across the planned project duration by allocating the effort to specific software engineering tasks.
- During early stages of project planning, a macroscopic schedule is developed.
- As the project gets under way, each entry on the macroscopic schedule is refined into a detailed schedule.

### **1. Basic Principles of Project Scheduling.**

1. **Compartmentalization:** The project must be compartmentalized into a number of manageable activities and tasks. To accomplish compartmentalization, both the product and the process are refined.
2. **Interdependency:** The interdependency of each compartmentalized activity or task must be determined. Some tasks must occur in sequence, while others can occur in parallel. Other activities can occur independently.
3. **Time allocation:** Each task to be scheduled must be allocated some number of work units (e.g., person- days of effort). In addition, each task must be assigned a start date and a completion date. Whether work will be conducted on a full-time or part-time basis.
4. **Effort validation:** Every project has a defined number of people on the software team. The project manager must ensure that no more than the allocated number of people have been scheduled at any given time.
5. **Defined responsibilities.** Every task that is scheduled should be assigned to a specific team member.
6. **Defined outcomes:** Every task that is scheduled should have a defined outcome. For software projects, the outcome is normally a work product (e.g., the design of a component) or a part of a work product. Work products are often combined in deliverables.
7. **Defined milestones:** Every task or group of tasks should be associated with a project milestone. A milestone is accomplished when one or more work products has been reviewed for quality and has been approved.

Each of these principles is applied as the project schedule evolves.

### **2. The Relationship between People and Effort**

- In a small software development project a single person can analyze requirements, perform design, generate code, and conduct tests. As the size of a project increases, more people must become involved.
- There is a common myth that is still believed by many managers who are responsible for software development projects: “If we fall behind schedule, we can always add more programmers and catch up later in the project.”
- Unfortunately, adding people late in a project often has a disruptive effect on the project, causing schedules to slip even further. The people who are added must learn the system, and the people who teach them are the same people who were doing the work.

- While teaching, no work is done, and the project falls further behind. In addition to the time it takes to learn the system, more people.
- Although communication is absolutely essential to successful software development, every new communication path requires additional effort and therefore additional time.

### 3. Effort Distribution

- A recommended distribution of effort across the software process is often referred to as the 40–20–40 rule.
- Forty percent of all effort is allocated to frontend analysis and design. A similar percentage is applied to back-end testing. You can correctly infer that coding (20 percent of effort) is deemphasized.
- Work expended on project planning rarely accounts for more than 2 to 3 percent of effort, unless the plan commits an organization to large expenditures with high risk.
- Customer communication and requirements analysis may comprise 10 to 25 percent of project effort.
- Effort expended on analysis or prototyping should increase in direct proportion with project size and complexity.
- A range of 20 to 25 percent of effort is normally applied to software design. Time expended for design review and subsequent iteration must also be considered.
- Because of the effort applied to software design, code should follow with relatively little difficulty.
- A range of 15 to 20 percent of overall effort can be achieved. Testing and subsequent debugging can account for 30 to 40 percent of software development effort.
- The criticality of the software often dictates the amount of testing that is required. If software is human rated (i.e., software failure can result in loss of life), even higher percentages are typical.

### SCHEDULING:

- Scheduling of a software project does not differ greatly from scheduling of any multitask engineering effort. Therefore, generalized project scheduling tools and techniques can be applied with little modification for software projects.
- Program evaluation and review technique (PERT) and the critical path method (CPM) are two project scheduling methods that can be applied to software development.

### 1. Time-Line Charts:

- When creating a software project schedule, begin with a set of tasks.
- If automated tools are used, the work breakdown is input as a task network or task outline. Effort, duration, and start date are then input for each task. In addition, tasks may be assigned to specific individuals.
- As a consequence of this input, a time-line chart, also called a Gantt chart, is generated.

- A time-line chart can be developed for the entire project. Alternatively, separate charts can be developed for each project function or for each individual working on the project.
- All project tasks (for concept scoping) are listed in the left hand column. The horizontal bars indicate the duration of each task. When multiple bars occur at the same time on the calendar, task concurrency is implied. The diamonds indicate milestones.
- Once the information necessary for the generation of a time-line chart has been input, the majority of software project scheduling tools produce project tables. —a tabular listing of all project tasks, their planned and actual start and end dates, and a variety of related information. Used in conjunction with the time-line chart, project tables enable you to track progress.

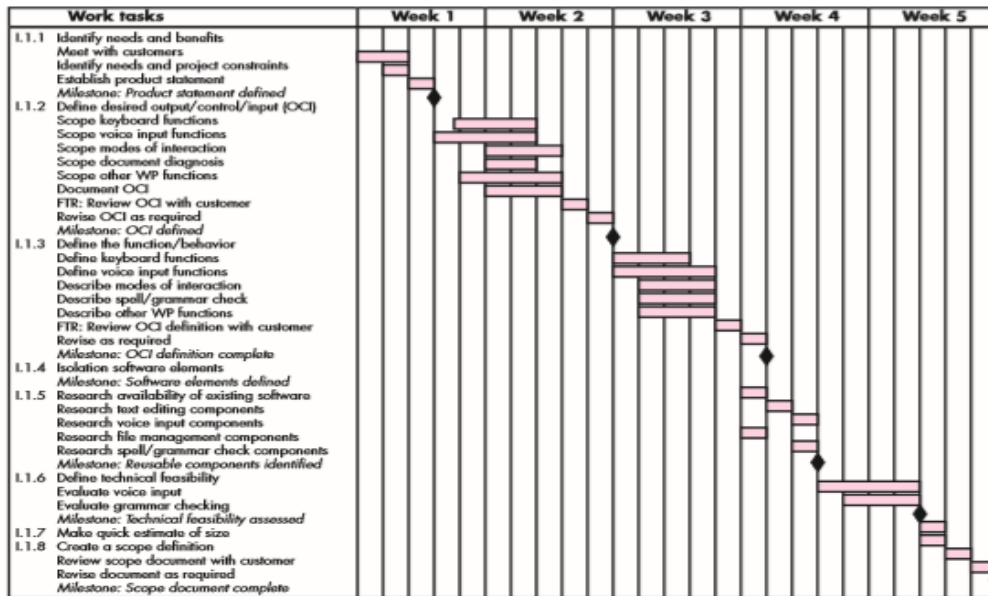

## 2. Tracking the Schedule

- If it has been properly developed, the project schedule becomes a road map that defines the tasks and milestones to be tracked and controlled as the project proceeds.
- Tracking can be accomplished in a number of different ways:
- Conducting periodic project status meetings in which each team member reports progress and problems.
- Evaluating the results of all reviews conducted throughout the software engineering process.
- Determining whether formal project milestones have been accomplished by the scheduled date.
- Comparing the actual start date to the planned start date for each project task listed in the resource table.
- Meeting informally with practitioners to obtain their subjective assessment of progress to date and problems on the horizon.
- Using earned value analysis to assess progress quantitatively.

In reality, all of these tracking techniques are used by experienced project managers.

### 3. Tracking Progress for an OO Project

#### Technical milestone: OO analysis complete

- All hierarchy classes defined and reviewed
- Class attributes and operations are defined and reviewed
- Class relationships defined and reviewed
- Behavioral model defined and reviewed
- Reusable classes identified

#### Technical milestone: OO design complete

- Subsystems defined and reviewed
- Classes allocated to subsystems and reviewed
- Task allocation has been established and reviewed
- Responsibilities and collaborations have been identified
- Attributes and operations have been designed and reviewed
- Communication model has been created and reviewed

#### Technical milestone: OO programming complete

- Each new design model class has been implemented
- Classes extracted from the reuse library have been implemented
- Prototype or increment has been built

#### Technical milestone: OO testing

- The correctness and completeness of the OOA and OOD models has been reviewed
- Class-responsibility-collaboration network has been developed and reviewed
- Test cases are designed and class-level tests have been conducted for each class
- Test cases are designed, cluster testing is completed, and classes have been integrated
- System level tests are complete

### Scheduling for WebApp Projects

- WebApp project scheduling distributes estimated effort across the planned time line (duration) for building each WebApp increment.
- This is accomplished by allocating the effort to specific tasks.
- The overall WebApp schedule evolves over time.
- During the first iteration, a macroscopic schedule is developed.
- This type of schedule identifies all WebApp increments and projects the dates on which each will be deployed.
- As the development of an increment gets under way, the entry for the increment on the macroscopic schedule is refined into a detailed schedule.
- Here, specific development tasks (required to accomplish an activity) are identified and scheduled.

### **EARNED VALUE ANALYSIS:**

- It is reasonable to ask whether there is a quantitative technique for assessing progress as the software team progresses through the work tasks allocated to the project schedule.
- A Technique for performing quantitative analysis of progress does exist. It is called earned value analysis (EVA).
- To determine the earned value, the following steps are performed:
  1. The budgeted cost of work scheduled (BCWS) is determined for each work task represented in the schedule. During estimation, the work (in person-hours or person-days) of each software engineering task is planned. Hence, BCWS<sub>i</sub> is the effort planned for work task i. To determine progress at a given point along the project schedule, the value of BCWS is the sum of the BCWS<sub>i</sub> values for all work tasks that should have been completed by that point in time on the project schedule.
  2. The BCWS values for all work tasks are summed to derive the budget at completion (BAC). Hence, BAC (BCWS<sub>k</sub>) for all tasks k
  3. Next, the value for budgeted cost of work performed (BCWP) is computed. The value for BCWP is the sum of the BCWS values for all work tasks that have actually been completed by a point in time on the project schedule.
    - Given values for BCWS, BAC, and BCWP, important progress indicators can be computed:

Schedule performance index,  $SPI = BCWP / BCWS$

Schedule variance,  $SV = BCWP - BCWS$

- SPI is an indication of the efficiency with which the project is utilizing scheduled resources. An SPI value close to 1.0 indicates efficient execution of the project schedule. SV is simply an absolute indication of variance from the planned schedule.
- Percent scheduled for completion =  $BCWS / BAC$

provides an indication of the percentage of work that should have been completed by time t.

- Percent complete =  $BCWP / BAC$

provides a quantitative indication of the percent of completeness of the project at a given point in time t. It is also possible to compute the actual cost of work performed (ACWP). The value for ACWP is the sum of the effort actually expended on work tasks that have been completed by a point in time on the project schedule. It is then possible to compute

Cost performance index,  $CPI = BCWP / ACWP$

Cost variance,  $CV = BCWP - ACWP$

A CPI value close to 1.0 provides a strong indication that the project is within its defined budget. CV is an absolute indication of cost savings (against planned costs) or shortfall at a particular stage of a project.

## **RFP RISK MANAGEMENT:**

### **A Hazard is**

Any real or potential condition that can cause injury, illness, or death to personnel; damage to or loss of a system, equipment or property; or damage to the environment. Simpler.... A threat of harm. A hazard can lead to one or several consequences.

### **A Risk is**

- The expectation of a loss or damage (consequence)
- The combined severity and probability of a loss
- The long term rate of loss

### **A potential problem (leading to a loss) that may - or may not occur in the future.**

- Risk Management is a set of practices and support tools to identify, analyze, and treat risks explicitly.
- Treating a risk means understanding it better, avoiding or reducing it (risk mitigation), or preparing for the risk to materialize.
- Risk management tries to reduce the probability of a risk to occur and the impact (loss) caused by risks.

### **Reactive versus Proactive Risk Strategies**

- Software risks
- Reactive versus Proactive Risk Strategies
- The majority of software teams rely solely on reactive risk strategies. At best, a reactive strategy monitors the project for likely risks. Resources are set aside to deal with them, should they become actual problems.
- The software team does nothing about risks until something goes wrong. Then, the team flies into action in an attempt to correct the problem rapidly. This is often called a fire-fighting mode.
- A considerably more intelligent strategy for risk management is to be proactive.
- A proactive strategy begins long before technical work is initiated. Potential risks are identified, their probability and impact are assessed, and they are ranked by importance. Then,
- The software team establishes a plan for managing risk. The primary objective is to avoid risk, but because not all risks can be avoided, the team works to develop a contingency plan that will enable it to respond in a controlled and effective manner.

### **Risk always involves two characteristics:**

- Risk always involves two characteristics: uncertainty—the risk may or may not happen; that is, there are no 100 percent probable risks—and loss—if the risk becomes a reality, unwanted consequences or losses will occur.
- When risks are analyzed, it is important to quantify the level of uncertainty and the degree of loss associated with each risk.



**Different categories of risks are follows:**

**1. Project risks**

- ❖ Threaten the project plan. That is, if project risks become real, it is likely that the project schedule will slip and that costs will increase.
- ❖ Project risks identify potential budgetary, schedule, personnel (staffing and organization), resource, stakeholder, and requirements problems and their impact on a software project.

**2. Technical risks**

- ❖ **Threaten the quality and timeliness of the software to be produced.**
- ❖ If a technical risk becomes a reality, implementation may become difficult or impossible. Technical risks identify potential design, implementation, interface, verification, and maintenance problems.
- ❖ In addition, specification ambiguity, technical uncertainty, technical obsolescence, and “leading-edge” technology are also risk factors. Technical risks occur because the problem is harder to solve than you thought it would be.

**3. Business risks**

- ❖ Business risks threaten the viability of the software to be built and often jeopardize the project or the product.
- ❖ Candidates for the top five business risks are
  1. building an excellent product or system that no one really wants (market risk)
  2. building a product that no longer fits into the overall business strategy for the company (strategic risk)
  3. building a product that the sales force doesn't understand how to sell (sales risk)
  4. losing the support of senior management due to a change in focus or a change in people (management risk)
  5. losing budgetary or personnel commitment (budget risks).

**Another general categorization of risks has been proposed by Charette.**

1. *Known risks* are those that can be uncovered after careful evaluation of the project plan, the business and technical environment in which the project is being developed, and other reliable information sources (e.g., unrealistic delivery date, lack of documented requirements or software scope, poor development environment).
2. *Predictable risks* are extrapolated from past project experience (e.g., staff turnover, poor communication with the customer, dilution of staff effort as ongoing maintenance requests are serviced).
3. *Unpredictable risks* are the joker in the deck. They can and do occur, but they are extremely difficult to identify in advance.

**UNIT- II: Requirement Analysis and Specification:** Software requirements: Functional and nonfunctional, user requirements, system requirements, software requirements document; Requirement engineering process: Feasibility studies, requirements elicitation and analysis, requirements validation, requirements management; Classical analysis: Structured system analysis, petri nets, data dictionary.

### **Functional and nonfunctional requirements:**

IEEE defines Requirement as:

1. A condition or capability needed by a user to solve a problem or achieve an objective
2. A condition or capability that must be met or possessed by a system or a system component to satisfy contract, standard, specification or formally imposed document
3. A documented representation of a condition or capability as in 1 or 2
  - Requirements may range from a high-level abstract statement of a service or of a system constraint to a detailed mathematical functional specification.
  - Requirements may serve a dual function
    - May be the basis for a bid for a contract - therefore must be open to interpretation
    - May be the basis for the contract itself - therefore must be defined in detail

“If a company wishes to let a contract for a large software development project, it must define its needs in a sufficiently abstract way that a solution is not pre-defined. The requirements must be written so that several contractors can bid for the contract, offering, perhaps, different ways of meeting the client organisation’s needs. Once a contract has been awarded, the contractor must write a system definition for the client in more detail so that the client understands and can validate what the software will do. Both of these documents may be called the *requirements document* for the system.”

### **FUNCTIONAL REQUIREMENTS:**

- Statements of services the system should provide, how the system should react to particular inputs and how the system should behave in particular situations.
- A functional requirement defines a function of a software system or its component.
- A function is described as a set of inputs, the behavior, and outputs.
- Functional requirements may be calculations, technical details, data manipulation and processing and other specific functionality that define *what* a system is supposed to accomplish.
- Behavioral requirements describing all the cases where the system uses the functional requirements are captured in *use cases*
- Functional requirements drive the application architecture of a system
- The plan for implementing *functional* requirements is detailed in the system design.

### **NON FUNCTIONAL REQUIREMENTS**

- A non-functional requirement is a requirement that specifies criteria that can be used to judge the operation of a system, rather than specific behaviors
- The plan for implementing non-functional requirements is detailed in the system architecture.
- Non-functional requirements are often called qualities of a system. Other terms for non-functional requirements are "constraints", "quality attributes", "quality goals", "quality of service requirements" and "non-behavioral requirements
- These define system properties and constraints e.g. reliability, response time and storage requirements. Constraints are I/O device capability, system representations, etc.
- Process requirements may also be specified mandating a particular CASE system, programming language or development method.
- Non-functional requirements may be more critical than functional requirements. If these are not met, the system may become useless.

## NON FUNCTIONAL REQUIREMENTS

- A non-functional requirement is a requirement that specifies criteria that can be used to judge the operation of a system, rather than specific behaviors
- The plan for implementing non-functional requirements is detailed in the system architecture.
- Non-functional requirements are often called qualities of a system. Other terms for non-functional requirements are "constraints", "quality attributes", "quality goals", "quality of service requirements" and "non-behavioral requirements
- These define system properties and constraints e.g. reliability, response time and storage requirements. Constraints are I/O device capability, system representations, etc.
- Process requirements may also be specified mandating a particular CASE system, programming language or development method.
- Non-functional requirements may be more critical than functional requirements. If these are not met, the system may become useless.

## Non-functional Requirements classifications

- Product requirements
  - Requirements which specify that the delivered product must behave in a particular way e.g. execution speed, reliability, etc.
- Organisational requirements
  - Requirements which are a consequence of organisational policies and procedures e.g. process standards used, implementation requirements, etc.
- External requirements
  - Requirements which arise from factors which are external to the system and its development process e.g. interoperability requirements, legislative requirements, etc.
- Non-functional requirement types

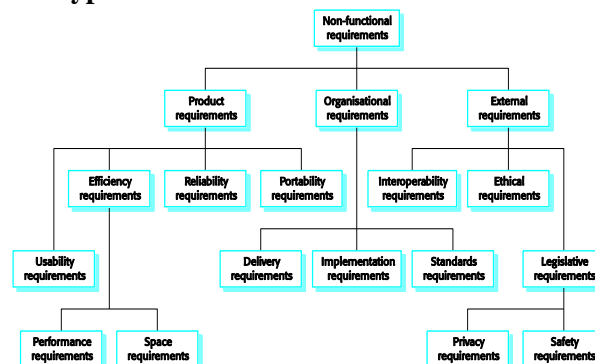

### Non – functional requirements examples

- **Product requirement**  
The user interface for the system shall be implemented as simple HTML without frames or Java applets.
- **Organisational requirement**  
The system development process and deliverable documents shall conform to the process and deliverables defined in XYZCo-SP-STAN-95.
- **External requirement**  
The system shall not disclose any personal information about customers apart from their name and reference number to the operators of the system.

### Non-Functional Requirements measures

---

<b>Property</b>	<b>Measure</b>
Speed	Processed transactions/second User/Event response time Screen refresh time
Size	M Bytes Number of ROM chips
Ease of use	Training time Number of help frames
Reliability	Mean time to failure Probability of unavailability Rate of failure occurrence Availability
Robustness	Time to restart after failure Percentage of events causing failure Probability of data corruption on failure
Portability	Percentage of target dependent statements Number of target systems

---

### User requirements and System requirements:

## **Business Requirements:**

- A high-level business objective of the organization that builds a product or of a customer who procures it
- Generally stated by the business owner or sponsor of the project
  - Example: A system is needed to track the attendance of employees
  - A system is needed to account the inventory of the organization

## **Contents of Business Requirements:**

- Purpose, Inscope, Out of Scope, Targeted Audiences
- Use Case diagrams
- Data Requirements
- Non Functional Requirements
- Interface Requirements
- Limitations
- Risks
- Assumptions
- Reporting Requirements
- Checklists

## **User requirements**

- A user requirement refers to a function that the user requires a system to perform.
- Made through statements in natural language and diagrams of the services the system provides and its operational constraints. Written for customers.
- User requirements are set by client and confirmed before system development.
  - For example, in a system for a bank the user may require a function to calculate interest over a set time period.

## **System Requirements**

- A system requirement is a more technical requirement, often relating to hardware or software required for a system to function.
  - System requirements may be something like - "The system must run on a server with IIS
  - System requirements may also include validation requirements such as "File upload is limited to .xls format
- System requirements are more commonly used by developers throughout the development life cycle. The client will usually have less interest in these lower level requirements.
- A structured document setting out detailed descriptions of the system's functions, services and operational constraints.

## **The Software Requirements Specifications (SRS) Document**

- The requirements document is the official statement of what is required of the system developers.
- Should include both a definition of user requirements and a specification of the system requirements.
- It is NOT a design document. As far as possible, it should set of WHAT the system should do rather than HOW it should do it.

### Users of a requirements document

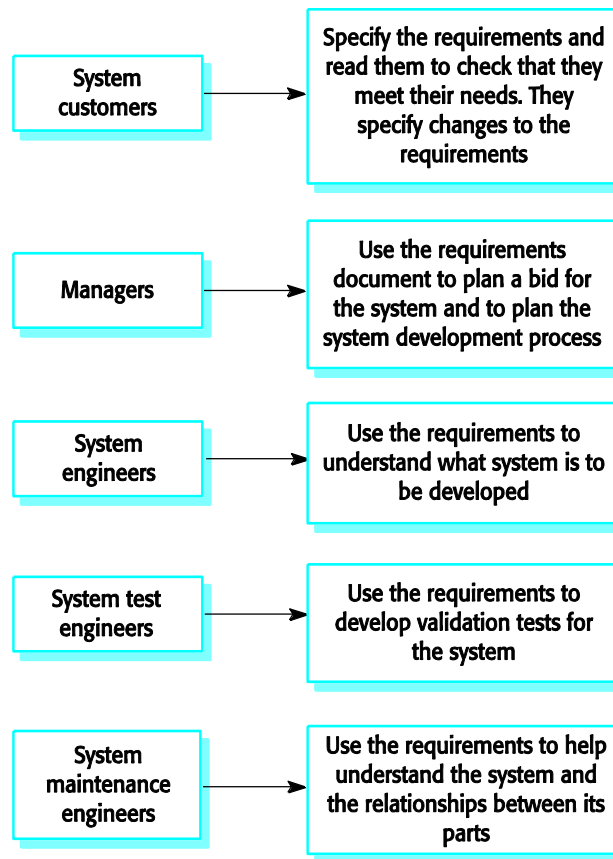

### Purpose of SRS

- Communication between the Customer, Analyst, System Developers, Maintainers
- Firm foundation for the design phase
- Support system testing activities
- Support project management and control
- Controlling the evolution of the system

### IEEE Requirements Standard

- Defines a generic structure for a requirements document that must be instantiated for each specific system.

- **Introduction.**
- **General description.**
- **Specific requirements.**
- **Appendices.**
- **Index.**

## **1. Introduction**

### **1.1 Purpose**

### **1.2 Scope**

### **1.3 Definitions, Acronyms and Abbreviations**

### **1.4 References**

### **1.5 Overview**

## **2. General description**

### **2.1 Product perspective**

### **2.2 Product function summary**

### **2.3 User characteristics**

### **2.4 General constraints**

### **2.5 Assumptions and dependencies**

## **3. Specific Requirements**

- **Functional requirements**
- **External interface requirements**
- **Performance requirements**
- **Design constraints**
- **Attributes**
  - eg. **Security, availability, maintainability, transferability/conversion**
- **Other requirements**
  - **Appendices**
  - **Index**

## **Suggested SRS Document Structure**

- **Preface**
  - **Should define the expected readership of the document and describe its version history, including a rationale for the creation of a new version and a summary of the changes made in each version**
- **Introduction**
  - **This should describe the for the system. It should briefly describe its functions and explain how it will work with other. It should describe how it will with other systems. It should describe how the system fits into the overall business or strategic objectives of the organization commissioning the software**

- **Glossary**
  - This should define the technical terms used in the document. Should not make assumptions about the experience or expertise of the reader
- **User Requirements Definition**
  - The services provided for the user and the non-functional system requirements should be described in this section. This description may use natural language, diagrams or other notations that are understandable by customers. Product and process standards which must be followed should be specified
- **System Architecture**
  - This chapter should present a high-level overview of the anticipated system architecture showing the distribution of functions across modules. Architectural components that re reused should be highlighted
- **System Requirements Specification**
  - This should describe the functional and non-functional requirements in more detail. If necessary, further detail may also be added to the non-functional requirements e.g. interfaces to other systems may be defined
- **System Models**
  - This should set out one or more system models showing the relationships between the system components and the system and its environment. These might be object models and data-flow models
- **System Evolution**
  - This should describe the fundamental assumptions on which the system is based and anticipated changes due to hardware evolution, changing user needs etc
- **Appendices**
  - These should provide detailed, specific information which is related to the application which is being developed. E.g. Appendices that may include hardware and database descriptions.
- **Index**
  - Several indexes to the document may be included



- A customer says “ I know you think you understand what I said, but what you don’t understand is what I said is not what I mean”
- Requirement engineering helps software engineers to better understand the problem to solve.
- It is carried out by software engineers (analysts) and other project stakeholders
- It is important to understand what the customer wants before one begins to design and build a computer based system
- Work products include user scenarios, functions and feature lists, analysis models

Requirements engineering (RE) is a systems and software engineering process which covers all of the activities involved in discovering, documenting and maintaining a set of requirements for a computer-based system The processes used for RE vary widely depending on the application domain, the people involved and the organisation developing the requirements.

- **Activities within the RE process may include:**
  - Requirements elicitation - discovering requirements from system stakeholders
  - Requirements Analysis and negotiation - checking requirements and resolving stakeholder conflicts
  - Requirements specification (Software Requirements Specification)- documenting the requirements in a requirements document
  - System modeling - deriving models of the system, often using a notation such as the Unified Modeling Language
  - Requirements validation - checking that the documented requirements and models are consistent and meet stakeholder needs
  - Requirements management - managing changes to the requirements as the system is developed and put into use
- **Requirements Engineering Processes:**

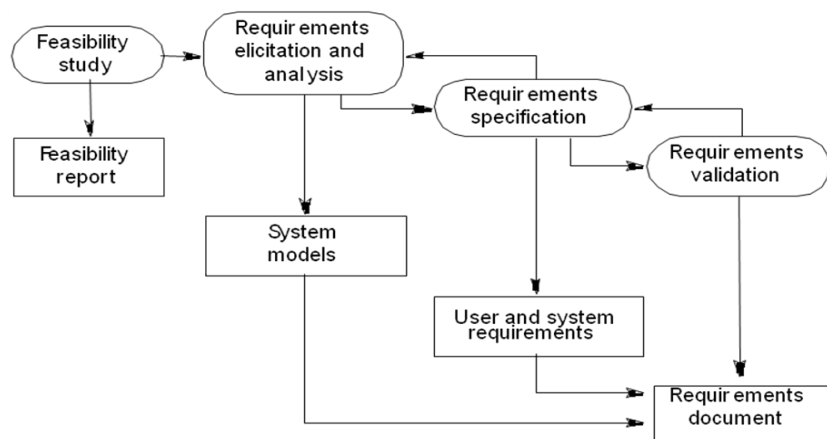

### Feasibility studies

- **The purpose of feasibility study is not to solve the problem, but to determine whether the problem is worth solving.**
- **A feasibility study decides whether or not the proposed system is worthwhile.**
- **The feasibility study concentrates on the following area.**
  - **Operational Feasibility**
  - **Technical Feasibility**
  - **Economic Feasibility**
- **A short focused study that checks**
  - **If the system contributes to organisational objectives;**
  - **If the system can be engineered using current technology and within budget;**
  - **If the system can be integrated with other systems that are used.**

**Based on information assessment (what is required), information collection and report writing.**

- **Questions for people in the organisation**
  - **What if the system wasn't implemented?**
  - **What are current process problems?**
  - **How will the proposed system help?**
  - **What will be the integration problems?**
  - **Is new technology needed? What skills?**
  - **What facilities must be supported by the proposed system?**

### **Requirement Elicitation and Analysis: Requirement discovery, Interviewing,**

**Requirements analysis** in systems engineering and software engineering, encompasses those tasks that go into determining the needs or conditions to meet for a new or altered product, taking account of the possibly conflicting requirements of the various stakeholders, such as beneficiaries or users.

**Requirements analysis is critical to the success of a systems or software project. The requirements should be documented, actionable, measurable, testable, traceable, related to identified business needs or opportunities, and defined to a level of detail sufficient for system design.**

### **Requirements analysis includes three types of activities**

- **Eliciting requirements: The task of identifying the various types of requirements from various sources including project documentation, (e.g. the project charter or definition), business process documentation, and stakeholder interviews. This is sometimes also called requirements gathering.**
- **Analyzing requirements: determining whether the stated requirements are clear,**

complete, consistent and unambiguous, and resolving any apparent conflicts.

- Recording requirements: Requirements may be documented in various forms, usually including a summary list and may include natural-language documents, use cases, user stories, or process specifications.

### Problems of Requirements Analysis

- Stakeholders don't know what they really want.
- Stakeholders express requirements in their own terms.
- Different stakeholders may have conflicting requirements.
- Organisational and political factors may influence the system requirements.
- The requirements change during the analysis process. New stakeholders may emerge and the business environment change.

**Requirements elicitation** is the practice of collecting the requirements of a system from users, customers and other stakeholders. Sometimes called Requirements Discovery Requirements elicitation is important because one can never be sure to get all requirements from the user and customer by just asking them what the system should do Requirements elicitation practices include interviews, questionnaires, user observation, workshops, brain storming, use cases, role playing and prototyping. Before requirements can be analyzed, modeled, or specified they must be gathered through an elicitation process. Requirements elicitation is a part of the requirements engineering process, usually followed by analysis and specification of the requirements.

### Requirements Analysis Process activities

- Requirements discovery
  - Interacting with stakeholders to discover their requirements. Domain requirements are also discovered at this stage.
- Requirements classification and organisation
  - Groups related requirements and organises them into coherent clusters.
- Prioritisation and negotiation
  - Prioritising requirements and resolving requirements conflicts.
- Requirements documentation
  - Requirements are documented and input into the next round of the spiral.

### Requirements discovery

- The process of gathering information about the proposed and existing systems and distilling (complete separation) the user and system requirements from this information.
- Sources of information include documentation, system stakeholders and the specifications of similar systems.

### Stakeholder Identification

- Stakeholders (SH) are people or organizations (legal entities such as companies, standards bodies) that have a valid interest in the system. They may be affected by it either directly or indirectly.
- Stakeholders are not limited to the organization employing the analyst. Other stakeholders will include:

- Anyone who operates the system (normal and maintenance operators)
- Anyone who benefits from the system (functional, political, financial and social beneficiaries)

### **Other stakeholders will include:**

- Anyone involved in purchasing or procuring the system. In a mass-market product organization, product management, marketing and sometimes sales act as surrogate consumers (mass-market customers) to guide development of the product
- Organizations which regulate aspects of the system (financial, safety, and other regulators)
- People or organizations opposed to the system (negative stakeholders)
- Organizations responsible for systems which interface with the system under design

### **Requirements Discovery -Viewpoints**

- Viewpoints are a way of structuring the requirements to represent the perspectives of different stakeholders. Stakeholders may be classified under different viewpoints.
- This multi-perspective analysis is important as there is no single correct way to analyse system requirements.
- Types of viewpoint
  - Interactor viewpoints
    - People or other systems that interact directly with the system. In an ATM, the customers and the account database are interactor VPs.
  - Indirect viewpoints
    - Stakeholders who do not use the system themselves but who influence the requirements. In an ATM, management and security staff are indirect viewpoints.
  - Domain viewpoints
    - Domain characteristics and constraints that influence the requirements. In an ATM, an example would be standards for inter-bank communications.

### **Interviewing**

- The interview is the primary technique for information gathering during the systems analysis phases of a development project. It is a skill which must be mastered by every analyst.
- The interviewing skills of the analyst determine what information is gathered, and the quality and depth of that information. Interviewing, observation, and research are the primary tools of the analyst.
- In formal or informal interviewing, the RE team puts questions to stakeholders about the system that they use and the system to be developed.
- Interviews are good for getting an overall understanding of what stakeholders do and how they might interact with the system.

### Goals of the Interview

- At each level, each phase, and with each interviewee, an interview may be conducted to:
  - Gather information on the company
  - Gather information on the function
  - Gather information on processes or activities
  - Uncover problems
  - Conduct a needs determination
  - Verification of previously gathered facts
  - Gather opinions or viewpoints
  - Provide information
  - Obtain leads for further interviews

### Interviews are two types of interview

- Closed interviews where a pre-defined set of questions are answered.
- Open interviews where there is no pre-defined agenda and a range of issues are explored with stakeholders.
- Normally a mix of closed and open-ended interviewing is undertaken.
- Interviews are not good for understanding domain requirements
  - Requirements engineers cannot understand specific domain terminology;
  - Some domain knowledge is so familiar that people find it hard to articulate or think that it isn't worth articulating.
- Effective Interviewers
  - Interviewers should be open-minded, willing to listen to stakeholders and should not have pre-conceived ideas about the requirements.
  - They should prompt the interviewee with a question or a proposal and should not simply expect them to respond to a question such as 'what do you want'.
- Information from interviews supplement other information about the system from documents, user observations, and so on
- Sometimes, apart from information from documents, interviews may be the only source of information about the system requirements
- It should be used alongside other requirements elicitation techniques

## Scenarios, Use cases, Ethnography:

### 1. Scenarios:

- Scenarios are real-life examples of how a system can be used.
- Scenarios can be particularly useful for adding detail to an outline requirements description.
- Each scenario covers one or more possible interactions
- Several forms of scenarios can be developed, each of which provides different types of information at different levels of detail about the system
- Scenarios may be written as text, supplemented by diagrams, screen shots and so on.
- A scenario may include
  - A description of the starting situation;
  - A description of the normal flow of events;
  - A description of what can go wrong;
  - Information about other concurrent activities that might be going on at the same time
  - A description of the system state when the scenario finishes.

Scenario-based elicitation involves working with stakeholders to identify scenarios and to capture details to be included in these scenarios. Scenarios may be written as text, supplemented by diagrams, screen shots, etc. Alternatively, a more structured approach such as event scenarios or use cases may be used.

### 2. Use Cases

- Use-cases are a scenario based technique in the UML which identify the actors in an interaction and which describe the interaction itself.
- A set of use cases should describe all possible interactions with the system.
- Sequence diagrams may be used to add detail to use-cases by showing the sequence of event processing in the system.
- Use-case approach helps with requirements prioritization

### Article printing use-case

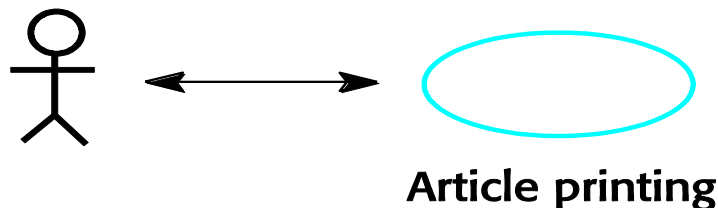

### A Use case can have high priority for

- It describes one of the business process that the system enables
- Many users will use it frequently
- A favoured user class requested it
- It provides capability that's required for regularity compliance
- Other system functions depend on its presence

### Social and organisational factors

- Software systems are used in a social and organisational context. This can influence or even dominate the system requirements.
- Social and organisational factors are not a single viewpoint but have influences on all viewpoints.
- Good analysts must be sensitive to these factors but currently no systematic way to tackle their analysis.

### 3. Ethnography

- A social scientists spends a considerable time observing and analysing how people actually work.
- People do not have to explain or articulate their work.
- Social and organisational factors of importance may be observed.
- Ethnographic studies have shown that work is usually richer and more complex than suggested by simple system models.

#### Focused ethnography

- Developed in a project studying the air traffic control process
- Combines ethnography with prototyping
- Prototype development results in unanswered questions which focus the ethnographic analysis.
- The problem with ethnography is that it studies existing practices which may have some historical basis which is no longer relevant.

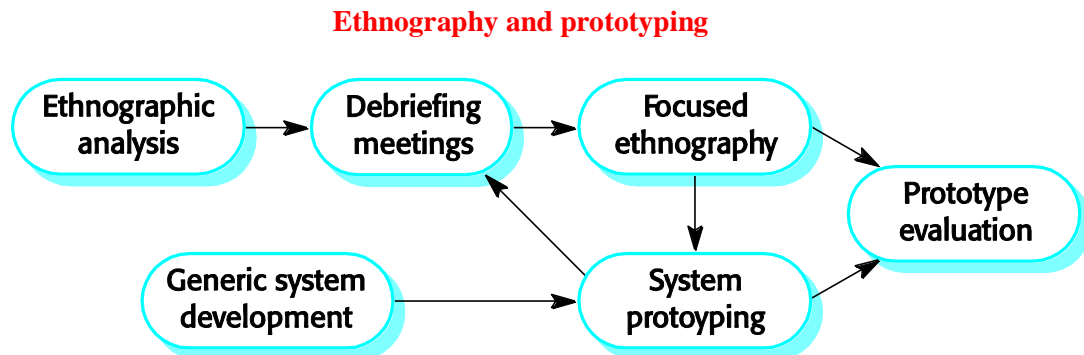

The ethnography informs the development of the prototype so that fewer prototype refinement cycles are required. Furthermore, the prototyping focuses the ethnography by identifying problems and questions that can then be discussed with the ethnographer.

## Requirement Validation

- Concerned with demonstrating that the requirements define the system that the customer really wants.
- Requirements error costs are high so validation is very important
  - Fixing a requirements error after delivery may cost up to 100 times the cost of fixing an implementation error.

During the requirements validation process, different types of checks should be carried out on the requirements in the requirements document. These checks include:

- **Validity.** Does the system provide the functions which best support the customer's needs?
- **Consistency.** Are there any requirements conflicts?
- **Completeness.** Are all functions required by the customer included?
- **Realism.** Can the requirements be implemented given available budget and technology?
- **Verifiability.** Can the requirements be checked?

## Requirements Validation Techniques

- Requirements reviews
  - Systematic manual analysis of the requirements.
- Prototyping
  - Using an executable model of the system to check requirements.
- Test-case generation
  - Developing tests for requirements to check testability.

## Requirements Reviews

- Regular reviews should be held while the requirements definition is being formulated.
- Both client and contractor staff should be involved in reviews.
- Reviews may be formal (with completed documents) or informal. Good communications between developers, customers and users can resolve problems at an early stage.
- Don't underestimate the problems involved in requirements validation. Ultimately, it is difficult to show that a set of requirements does in fact meet a user's needs. Users need to picture the system in operation and imagine how that system would fit into their work.
- It is hard even for skilled computer professionals to perform this type of abstract analysis and harder still for system users. As a result, you rarely find all requirements problems during the requirements validation process. It is inevitable that there will be further requirements changes to correct omissions and misunderstandings after the requirements document has been agreed upon.



## Requirement Management

Requirements management is the process of managing changing requirements during the requirements engineering process and system development.

Requirements are inevitably incomplete and inconsistent

- New requirements emerge during the process as business needs change and a better understanding of the system is developed;
- Different viewpoints have different requirements and these are often contradictory.

## Requirements Change

- The priority of requirements from different viewpoints changes during the development process.
- System customers may specify requirements from a business perspective that conflict with end-user requirements.
- The business and technical environment of the system changes during its development.

## Requirements Evolution

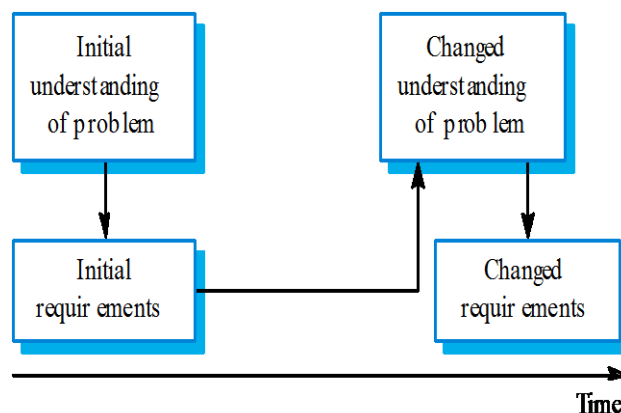

## Enduring requirements

- These are relatively stable requirements that derive from the core activity of the organization
- Relate directly to the domain of the system
- These requirements may be derived from domain models that show the entities and relations which characterize an application domain
- For example, in a hospital there will always be requirements concerned with patients, doctors, nurses, treatments, etc

### Volatile requirements

- These are requirements that are likely to change during the system development process or after the system has been become operational.
- Examples of volatile requirements are requirements resulting from government health-care policies or healthcare charging mechanisms.

### Traceability

- Traceability is concerned with the relationships between requirements, their sources and the system design
- Source traceability
  - Links from requirements to stakeholders who proposed these requirements;
- Requirements traceability
  - Links between dependent requirements;
- Design traceability
  - Links from the requirements to the design;
- Requirements storage
  - Requirements should be managed in a secure, managed data store.
- Change management
  - The process of change management is a workflow process whose stages can be defined and information flow between these stages partially automated.
- Traceability management
  - Automated retrieval of the links between requirements.

### Requirements Management Planning

- During the requirements engineering process, one has to plan:
  - Requirements identification
    - How requirements are individually identified;
  - A change management process
    - The process followed when analysing a requirements change;
  - Traceability policies
    - The amount of information about requirements relationships that is maintained;
  - CASE tool support
    - The tool support required to help manage requirements change;
- Should apply to all proposed changes to the requirements.
- Principal stages
  - Problem analysis. Discuss requirements problem and propose change;
  - Change analysis and costing. Assess effects of change on other requirements;
  - Change implementation. Modify requirements document and other documents to reflect change.

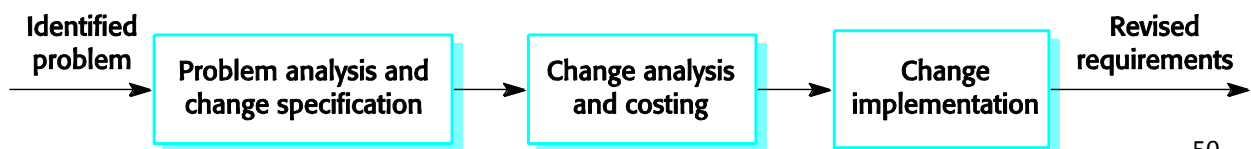

## Classical Analysis:

### Structured system analysis:

- Throughout the phases of analysis and design, the analyst should proceed step by step, obtaining feedback from users and analyzing the design for omissions and errors.
- Moving too quickly to the next phase may require the analyst to rework portions of the design that were produced earlier.
- They Structured a project into small, well-defines activities and specify the sequence and interaction of these activities.
- They use diagrammatic and other modeling techniques to give a more precise (structured) definition that is understandable by both users and developers.
- Structured analysis provides a clear requirements statements that everyone can understand and is a firm foundation for subsequent design and implementation.
- Part of the problem with systems analysts just asking ‘the right questions’ that it is often difficult for a technical person to describe the system concepts back to the user can understand.
- Structured methods generally include the use of easily understood, non technical diagrammatic techniques.
- It is important that these diagram do not contain computer jargon and technical detail that the user wont understand – and does not need understand.

### High-Level Petri Nets

- The classical Petri net was invented by Carl Adam Petri in 1962.
- A lot of research has been conducted (>10,000 publications).
- Until 1985 it was mainly used by theoreticians.
- Since the 80’s their practical use has increased because of the introduction of high-level Petri nets and the availability of many tools.
- High-level Petri nets are Petri nets extended with
  - colour (for the modelling of attributes)
  - time (for performance analysis)
  - hierarchy (for the structuring of models, DFD's)

### Why do we need Petri Nets?

- Petri Nets can be used to rigorously define a system (reducing ambiguity, making the operations of a system clear, allowing us to prove properties of a system etc.)
- They are often used for distributed systems (with several subsystems acting independently) and for systems with resource sharing.
- Since there may be more than one transition in the Petri Net active at the same time (and we do not know which will ‘fire’ first), they are non-deterministic.

A Petri net is a network composed of places ( ) and transitions

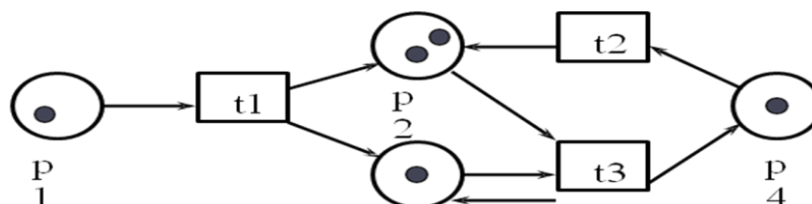

Connections are directed and between a place and a transition, or a transition and a place (e.g. Between “p1 and t1” or “t1 and p2” above).  
 Tokens () are the dynamic objects.

**Enabling Condition**

- Transitions are the active components and places and tokens are passive components.
- A transition is enabled if each of the input places contains tokens.

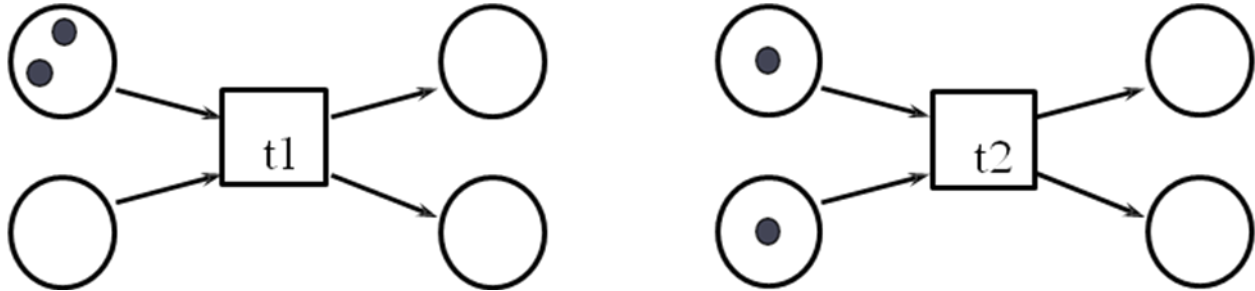

Transition t1 is not enabled, transition t2 is enabled.

**Non-Determinism in Petri Nets**

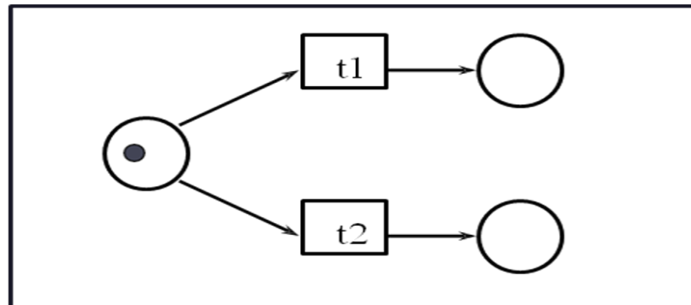

Two transitions fight for the same token: conflict.  
 Even if there are two tokens, there is still a conflict.  
 The next transition to fire (t1 or t2) is arbitrary (non-deterministic).

**Data Dictionary**

- I. A tool for recording and processing information (metadata) about the data that an organization uses.
- II. A central catalogue for metadata.
- III. Can be integrated within the DBMS or be separate.
- IV. May be referenced during system design, programming, and by actively-executing programs.
- V. Can be used as a repository for common code (e.g. library routines).

Benefits of a DDS are mainly due to the fact that it is a central store of information about the database.

- improved documentation and control
- consistency in data use
- easier data analysis
- reduced data redundancy
- simpler programming
- the enforcement of standards
- better means of estimating the effect of change.

#### **A DDS should provide two sets of facilities:**

- To record and analyze data requirements independently of how they are going to be met - conceptual data models (entities, attributes, relationships).
- To record and design decisions in terms of database or file structures implemented and the programs which access them - internal schema.

One of the main functions of a DDS is to show the relationship between the conceptual and implementation views. The mapping should be consistent - inconsistencies are an error and can be detected here.

#### **Management Advantages**

A number of possible benefits may come from using a DDS:

- improve control and knowledge about the data resource.
- allows accurate assessment of cost and time scale to effect any changes.
- reduces the clerical load of database administration, and gives more control
- over the design and use of the database.
- accurate data definitions can be provided securely directly to programs.
- aid the recording, processing, storage and destruction of data and associated documents.

#### **Management Disadvantages**

A DDS is a useful management tool, but at a price.

- The DDS 'project' may itself take two or three years.
- It needs careful planning, defining the exact requirements designing its contents, testing, implementation and evaluation.
- The cost of a DDS includes not only the initial price of its installation and any hardware requirements, but also the cost of collecting the information entering it into the DDS, keeping it up-to-date and enforcing standards.
- The use of a DDS requires management commitment, which is not easy to achieve, particularly where the benefits are intangible and long term.

**UNIT- III: Software Design:** Design process: Design concepts, design model, design heuristic, architectural design, architectural styles, accessing alternative architectural designs, and architectural mapping using data flow.

**User interface design:** Interface analysis, interface design; Component level design: Designing class based components, traditional components.

### **Design process:**

**Software design is an iterative process through which requirements are translated into a “blueprint” for constructing the software. Initially, the blue print depicts a holistic view of software. That is, the design is represented at a high level of abstraction— a level that can be directly traced to the specific system objective and more detailed data, functional, and behavioral requirements.**

## **1. Software Quality Guidelines and Attributes**

- **Design Guidelines**

- **A good design should**

- exhibit good architectural structure
- be modular
- contain distinct representations of data, architecture, interfaces, and components (modules)
- lead to data structures that are appropriate for the objects to be implemented and be drawn from recognizable design patterns
- lead to components that exhibit independent functional characteristics
- lead to interfaces that reduce the complexity of connections between modules and with the external environment
- be derived using a reputable method that is driven by information obtained during software requirements analysis

- **Quality Guidelines**

- A design should exhibit an architecture that (1) has been created using recognizable architectural styles or patterns, (2) is composed of components that exhibit good design characteristics (these are discussed later in this chapter), and (3) can be implemented in an evolutionary fashion, thereby facilitating implementation and testing.
- A design should be modular; that is, the software should be logically partitioned into elements or subsystems.
- A design should contain distinct representations of data, architecture, interfaces,

and components.

- A design should lead to data structures that are appropriate for the classes to be implemented and are drawn from recognizable data patterns.
  - A design should lead to components that exhibit independent functional characteristics.
  - A design should lead to interfaces that reduce the complexity of connections between components and with the external environment.
  - A design should be derived using a repeatable method that is driven by information obtained during software requirements analysis.
  - A design should be represented using a notation that effectively communicates its meaning.
- **Quality attributes**
    - **Functionality is assessed by evaluating the feature set and capabilities of the program, the generality of the functions that are derived and the security of the overall system**
    - **Usability is assessed by considering human factors, overall aesthetics, consistency and documentation**
    - **Reliability is evaluated by measuring the frequency and severity of failure, the accuracy of output results, the mean-time-to-failure, the ability to recover from failure, and the predictability of the program**
    - **Performance is measured by processing speed, response time, resource consumption, throughput, and efficiency**
    - **Supportability combines the ability to extend the program, adaptability, serviceability, testability, compatibility, configurability, the ease with which a system can be installed, and the ease with which problems can be localized**

## **2. The Evolution of Software Design:**

- The evolution of software design is a continuing process that has now spanned almost six decades.
- All these methods have a number of common characteristics:
  1. A mechanism for the translation of the requirements model into a design representation,
  2. A notation for representing functional components and their interfaces,
  3. Heuristics for refinement and partitioning, and

#### 4. Guidelines for quality assessment.

Regardless of the design method that is used, you should apply a set of basic concepts to data, architectural, interface, and component-level design. These concepts are considered in the sections that follow

### Design Concepts:

#### 1. Abstraction

- Abstraction is the process by which data and programs are defined with a representation similar in form to its meaning (semantics), while hiding away the implementation details.
- Abstraction tries to reduce and factor out details so that the programmer can focus on a few concepts at a time
- At the highest level of abstraction, a solution is stated in broad terms using the language of the problem environment. At the lower levels of abstraction, a more detailed description of the solution is provided.

Abstraction can be

- Data abstraction is a named collection of data that describes a data object. Data abstraction for 'door' would encompass a set of attributes that describe the door (e.g. door type, swing direction, opening mechanism, weight, dimensions).
- The procedural abstraction 'open' would make use of information contained in the attributes of the data abstraction 'door'

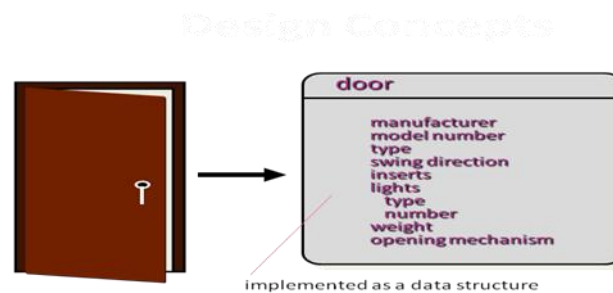

- Procedural abstraction refers to a sequence of instructions that have as specific and limited function. The name of the procedural abstraction implies these functions, but specific details are suppressed.

e.g. 'open' for a door. 'open' implies a long sequence of procedural steps (e.g. walk to the door, reach out and grasp knob, turn knob, turn knob and pull door, step away from moving door, etc)



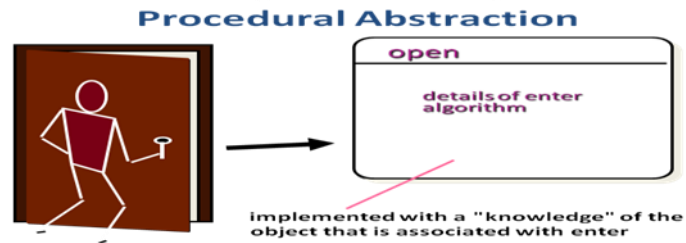

## 2. Architecture

- Architecture is the structure or organization of program components (modules), the manner in which these components interact, and the structure of data that are used by the components. Architectural design can be represented using ,
- Structural models represent architecture as an organized collection of program components
- Framework models increase the level of design abstraction by attempting to identify repeatable architectural design frameworks that are encountered in similar types of application
- Dynamic models address the behavioural aspects of the program architecture, indicating how the structure or system configuration may change as a function of external events
- Procedural models focus on the design of the business or technical process that the system must accommodate
- Function models can be used to represent the functional hierarchy of a system

## 3. Patterns

- Design pattern describes a design structure that solves a particular design problem within a specific context.
- Each design pattern is to provide a description that enables a designer to determine
  - Whether the pattern is applicable to the current work
  - Whether the pattern can be reused
  - Whether the pattern can serve as a guide for developing a similar, but functionally or structurally different pattern

## 4. Separation of Concerns

- Separation of concerns is a design concept that suggests that any complex problem can be more easily handled if it is subdivided into pieces that can each be solved and/or optimized independently.

- A concern is a feature or behavior that is specified as part of the requirements model for the software.
- By separating concerns into smaller, and therefore more manageable pieces, a problem takes less effort and time to solve.
- For two problems, p1 and p2, if the perceived complexity of p1 is greater than the perceived complexity of p2, it follows that the effort required to solve p1 is greater than the effort required to solve p2.

## 5. Modularity

- Software is divided into separately named and addressable components, called modules that are integrated to satisfy problem requirements
- Design has to be modularized so that development can be more easily planned, software increments can be defined and delivered, changes can be more easily accommodated, testing and debugging can be conducted more efficiently and long-term maintenance can be conducted without serious side effects

*easier to build, easier to change, easier to fix ...*

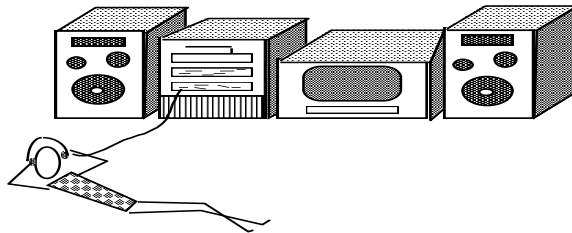

## 6. Information Hiding

- Modules should be specified and designed so that information ( algorithms and data) contained in a module is inaccessible to other modules that have no need for such information
- Hiding implies that effective modularity can be achieved by defining a set of independent modules that communicate with one another only that information necessary to achieve software function
- Hiding defines and enforces access constraints to both data procedural detail within a module and any local data structure used by the module
- The use of information hiding as a design criterion for modular systems provides the benefits when modifications are required during testing and later during software maintenance

## 7. Information Hiding

- Reduces the likelihood of “side effects”
- Limits the global impact of local design decisions
- Emphasizes communication through controlled interfaces
- Discourages the use of global data
- Leads to encapsulation—an attribute of high quality design
- Results in higher quality software

### Functional Independence

- Functional independence is achieved by developing modules with ‘single minded’ function and avoids excessive interaction with other modules.
- Independent modules are easier to maintain because secondary effects caused by design or code modification are limited, error propagation is reduced

### Independence is assessed using two qualitative criteria

- Cohesion which is an indication of the relative functional strength of a module. A cohesive module performs a single task, requiring little interaction with other components in other parts of a program
- Coupling is an indication of the relative interdependence among modules. Coupling depends on the interface complexity between modules, the point at which entry or reference is made to a module, and what data pass across the interface

## 8. Refinement

- Refinement is a process of elaboration. Refinement causes the designer to elaborate on the original statement, providing more and more detail as each successive refinement occurs.
- Refinement helps the designer to reveal low-level details as design progresses.

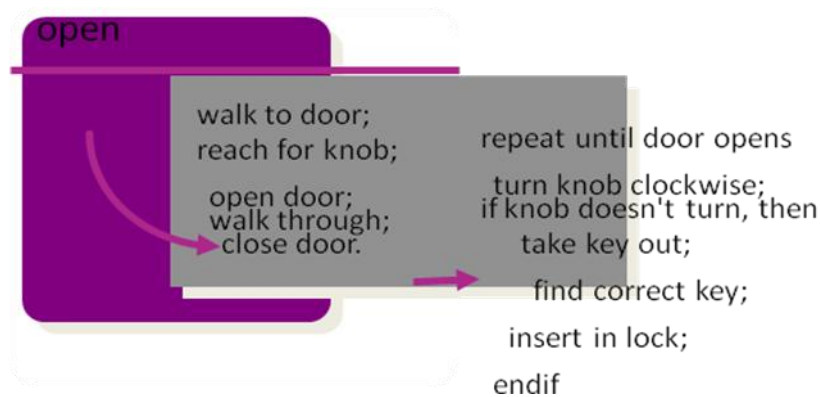

## 9. Refactoring

- Refactoring is the process of changing a software system in such a way that it does not alter the external behaviour of the code yet improves its internal structure
- 
- When software is refactored, the existing design is examined for redundancy, unused design elements, inefficient or unnecessary algorithms, poorly constructed or inappropriate data structures, or any other design failure that can be corrected to yield a better design

## 10. Aspects

- As requirements analysis occurs, a set of “concerns” is uncovered. These concerns “include requirements, use cases, features, data structures, quality-of-service issues, variants, intellectual property boundaries, collaborations, patterns and contracts”
- Ideally, a requirements model can be organized in a way that allows you to isolate each concern (requirement) so that it can be considered independently.
- In practice, however, some of these concerns span the entire system and cannot be easily compartmentalized. As design begins, requirements are refined into a modular design representation.
- Consider two requirements, A and B. Requirement A crosscuts requirement B “if a software decomposition [refinement] has been chosen in which B cannot be satisfied without taking A into account”.

## 11. Refactoring

- An important design activity suggested for many agile methods, refactoring is a reorganization technique that simplifies the design (or code) of a component without changing its function or behavior
- When software is refactored, the existing design is examined for redundancy, unused design elements, inefficient or unnecessary algorithms, poorly constructed or inappropriate data structures, or any other design failure that can be corrected to yield a better design.

## 12. Object-Oriented Design Concepts

- The object-oriented (OO) paradigm is widely used in modern software engineering.
- OO design concepts such as classes and objects, inheritance, messages, and polymorphism, among others.
-

### 13. Design classes

- As the design model evolves, a set of design classes are to be defined that
  - Refine the analysis classes by providing design detail that will enable the classes to be implemented
  - Create a new set of design classes that implement a software infrastructure to support the business solution

#### The Design Model:

Design model can be viewed as

- Process dimension indicating the evolution of the design model as design tasks are executed as part of the software process.
- Abstraction dimension represents the level of detail as each element of the analysis model is transformed into a design equivalent and then refined iteratively

#### Design Model Elements are as follows

- Data design elements
- Architectural design elements
- Interface design elements
- Component-level design elements
- Deployment-level design elements

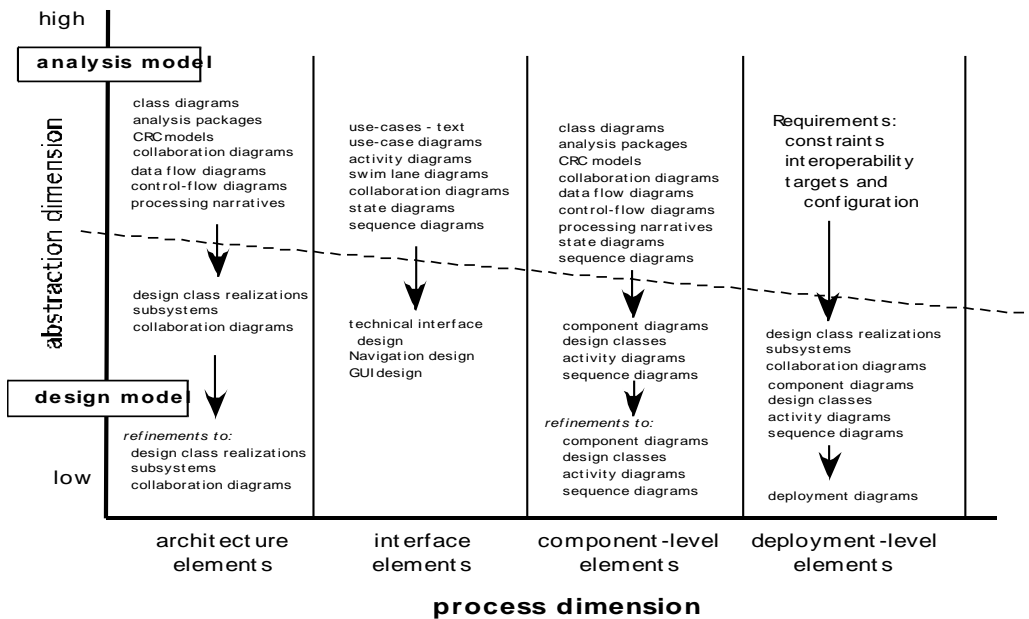

#### 1. Data design elements

- Data design creates a model of data and/or information that is represented at a high

level of abstraction.

- Data model is then refined into progressively more implementation-specific representations that can be processed by the computer-based system

Architectural level → databases and files

Component level → data structures

## 2. Architectural design elements

- The architectural design for software is the equivalent to the floor plan of a house. The floor plan depicts the overall layout of the rooms; their size, shape, and relationship to one another; and the doors and windows that allow movement into and out of the rooms. The floor plan gives us an overall view of the house. Architectural design elements give us an overall view of the software.
  - The architectural model is derived from
    - Information about the application domain for the software to be built
    - Specific requirements model elements such as data flow diagrams or analysis classes, their relationships and collaborations for the problem at hand
    - The availability of architectural patterns and styles

## 3. Interface design elements

- The interface design elements for software tell how information flows into and out of the system and how it is communicated among the components defined as part of the architecture
- Important elements of interface design
  - The user interface (UI): Usability design incorporates aesthetic elements (e.g., layout, color, graphics, interaction mechanisms), ergonomic elements (e.g., information layout and placement, metaphors, UI navigation), and technical elements (e.g., UI patterns, reusable components). In general, the UI is a unique subsystem within the overall application architecture.
  - External interfaces to other systems, devices, networks or other producers or consumers of informationThe design of external interfaces requires definitive information about the entity to which information is sent or received.
  - Internal interfaces between various design componentsThe design of internal interfaces is closely aligned with component-level design

## Design Model - Interface Elements

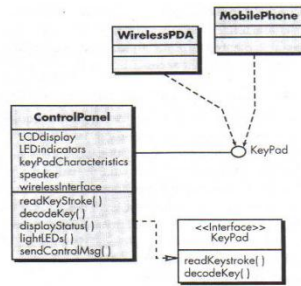

### 4. Component-level design elements

- The component-level design for software is the equivalent to a set of detailed drawings (and specifications) for each room in a house. These drawings depict wiring and plumbing within each room, the location of electrical receptacles and wall switches, faucets, sinks, showers, tubs, drains, cabinets, and closets.
  - Component-level design for software fully describes the internal detail of each software component.
  - Component-level design defines data structures for all local data objects and algorithmic detail for all processing that occurs within a component and an interface that allows access to all component operations
  - The design details of a component can be modelled at many different levels of abstraction.
  - An UML activity diagram can be used to represent processing logic. Detailed procedural flow for a component can be represented using either pseudocode or diagrammatic form (e.g., flowchart or box diagram).

## Component Elements



### 5. Deployment-level design elements

- Deployment-level design elements indicate how software functionality and subsystems will be allocated within the physical computing environment that will support the software.

- Deployment diagrams shows the computing environment but does not explicitly indicate configuration details.

### **What is software Architecture?**

- When you consider the architecture of a building, many different attributes come to mind. At the most simplistic level, you think about the overall shape of the physical structure. But in reality, architecture is much more. It is the manner in which the various components of the building are integrated to form a cohesive whole.
- The software architecture of a program or computing system is the structure or structures of the system, which comprise software components, the externally visible properties of those components, and the relationships among them
- Software architecture enables to
  - Analyze the effectiveness of the design in meeting its stated requirements
  - Consider architectural alternatives at a stage when making design changes is still relatively easy
  - Reduce the risks associated with the construction of the software
  - Architectural design represents the structure of data and program components that are required to build a computer-based system.
  - It considers the architectural style that the system will take, the structure and properties of the components that constitute the system, and the interrelationships that occur among all architectural components of a system
  - Architecture considers two levels of the design – data design and architectural design. Data design enables us to represent the data component of the architecture.
  - Architectural design focuses on the representation of the structure of software components, their properties, and interactions

### **Why Is Architecture Important?**

- Representations of software architecture are an enabler for communication between all parties, interested in the development of a computer-based system.
- The architecture highlights early design decisions that will have a profound impact on all software engineering work that follows and, as important, on ultimate success of the system as an operational entity.
- Architecture constitutes a relatively small, intellectually graspable model of how the system is structured and how its components work together.



## Architectural Descriptions

- Each of us has a mental image of what the word architecture means. In reality, however, it means different things to different people.
- The implication is that different stakeholders will see an architecture from different viewpoints that are driven by different sets of concerns.
- An architectural description is actually a set of work products that reflect different views of the system.
- An architectural description of a software-based system must exhibit characteristics that are analogous to those noted for the office building.
- Developers want clear, decisive guidance on how to proceed with design.
- Customers want a clear understanding on the environmental changes that must occur and assurances that the architecture will meet their business needs.
- Other architects want a clear, salient understanding of the architecture’s key aspects.” Each of these “wants” is reflected in a different view represented using a different viewpoint.

## Architectural Decisions

- Each view developed as part of an architectural description addresses a specific stakeholder concern.
- To develop each view (and the architectural description as a whole) the system architect considers a variety of alternatives and ultimately decides on the specific architectural features that best meet the concern.
- Therefore, architectural decisions themselves can be considered to be one view of the architecture.
- The reasons that decisions were made provide insight into the structure of a system and its conformance to stakeholder concerns.

## Software Architectural Styles

1. A Brief Taxonomy of Architectural Styles
  2. Architectural Patterns
  3. Organization and Refinement
- The software that is built for computer-based systems exhibit one of many architectural styles

- Each style describes a system category that encompasses
  - A set of component types that perform a function required by the system
  - A set of connectors (subroutine call, remote procedure call, data stream, socket) that enable communication, coordination, and cooperation among components
  - constraints that define how components can be integrated to form the system;
  - semantic models that enable a designer to understand the overall properties of a system by analyzing the known properties of its constituent parts.

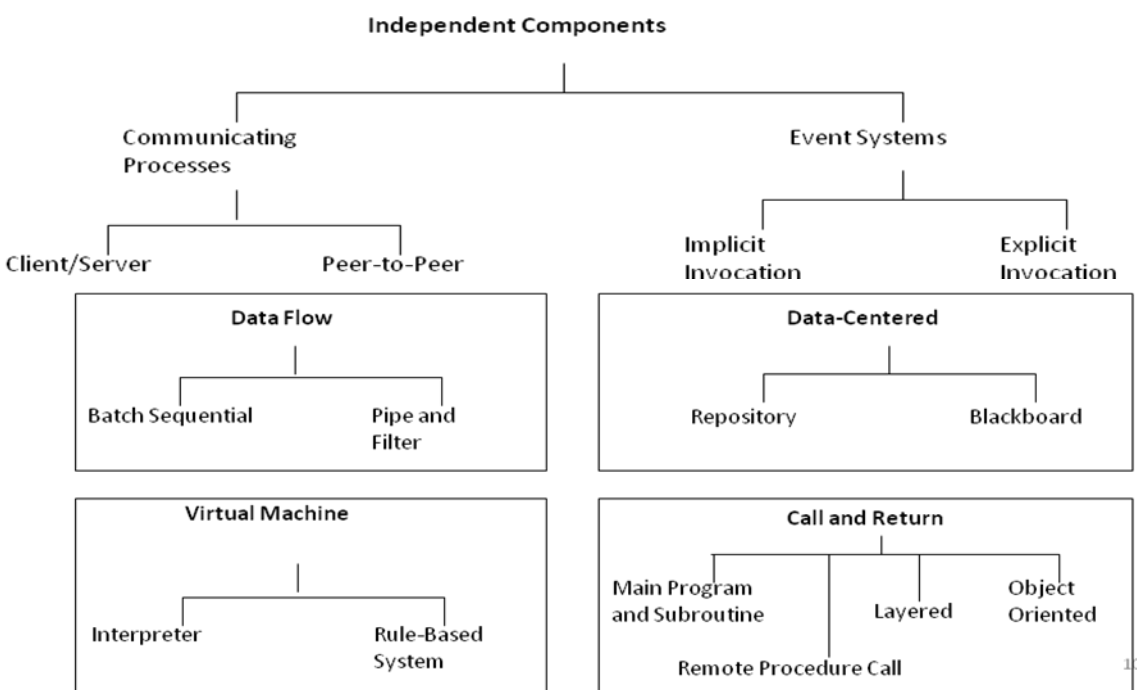

### A Brief Taxonomy of Architectural Styles

- **Data-centered architectures.** A data store (e.g., a file or database) resides at the center of this architecture and is accessed frequently by other components that update, add, delete, or otherwise modify data within the store.
- Illustrates a typical data-centered style. Client software accesses a central repository. In some cases the data repository is passive. That is, client software accesses the data independent of any changes to the data or the actions of other client software. A variation on this approach transforms the repository into a “blackboard

## Data-Centered Style

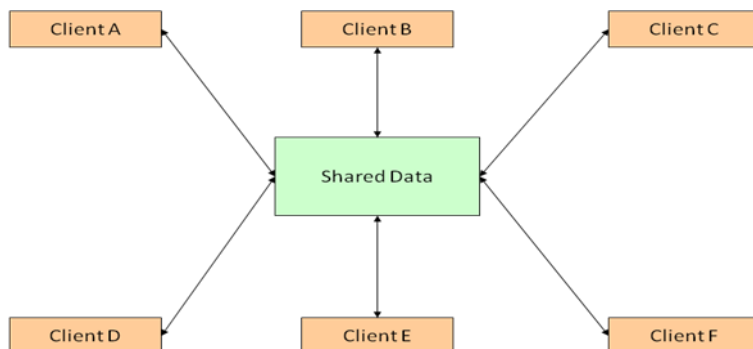

## Data-flow architectures

- This architecture is applied when input data are to be transformed through a series of computational or manipulative components into output data.
- A pipe-and-filter pattern show has a set of components, called *filters*, connected by *pipes* that transmit data from one component to the next.
- Each filter works independently of those components upstream and downstream, is designed to expect data input of a certain form, and produces data output (to the next filter) of a specified form.
- However, the filter does not require knowledge of the workings of its neighboring filters.

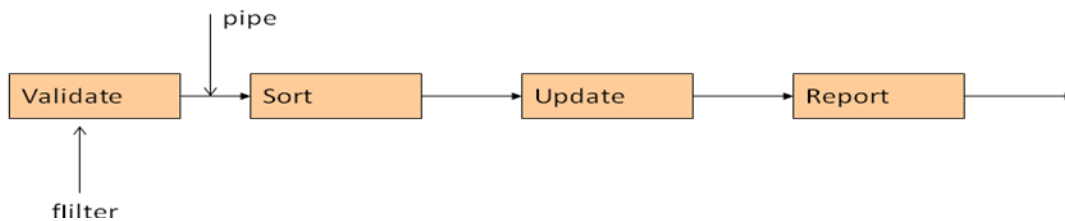

## Call and return architectures.

- This architectural style enables you to achieve a program structure that is relatively easy to modify and scale.
- A number of substyles exist within this category:
- *Main program/subprogram architectures:* This classic program structure decomposes function into a control hierarchy where a “main” program invokes a number of program components that in turn may invoke still other components. Figure illustrates architecture of this type.

- **Remote procedure call architectures:** The components of a main program/subprogram architecture are distributed across multiple computers on a network.

### Call-and-Return Style

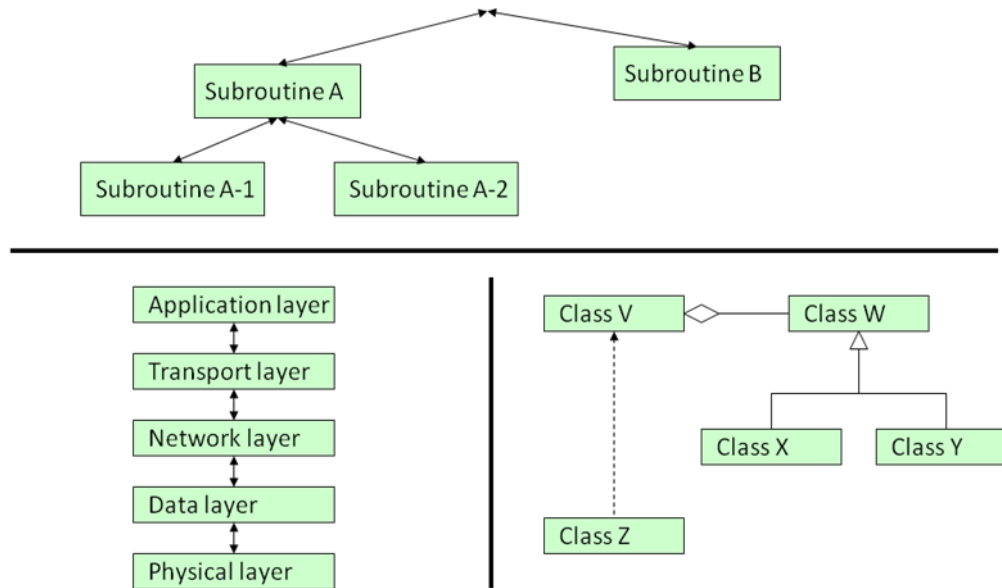

### Object-oriented architectures

- The components of a system encapsulate data and the operations that must be applied to manipulate the data.
- Communication and coordination between components are accomplished via message passing.

### Layered architectures.

- The basic structure of a layered architecture is illustrated in Figure.
- A number of different layers are defined, each accomplishing operations that progressively become closer to the machine instruction set.
- At the outer layer, components service user interface operations.
- At the inner layer, components perform operating system interfacing.
- Intermediate layers provide utility services and application software functions.

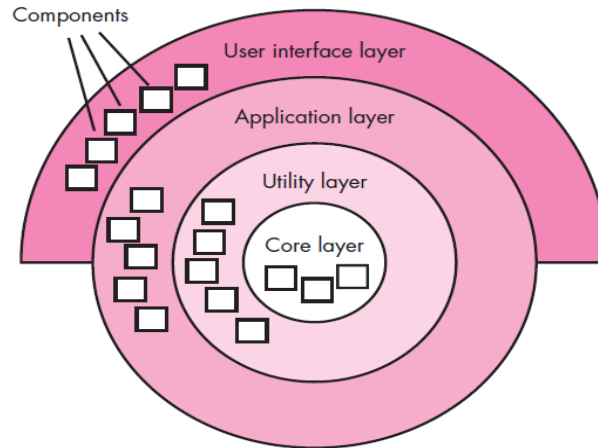

- As the requirements model is developed, you'll notice that the software must address a number of broad problems that span the entire application.
- For example, the requirements model for virtually every e-commerce application is faced with the following problem: *How do we offer a broad array of goods to a broad array of customers and allow those customers to purchase our goods online?*
- Architectural patterns address an application-specific problem within a specific context and under a set of limitations and constraints. The pattern proposes an architectural solution that can serve as the basis for architectural design.

### Organization and Refinement

- Because the design process often leaves you with a number of architectural alternatives, it is important to establish a set of design criteria that can be used to assess an architectural design that is derived.

### Control

- How is control managed within the architecture? Does a distinct control hierarchy exist, and if so, what is the role of components within this control hierarchy? How do components transfer control within the system? How is control shared among components? What is the control topology (i.e., the geometric form that the control takes)? Is control synchronized or do components operate asynchronously?

### Data

- How are data communicated between components? Is the flow of data continuous, or are data objects passed to the system sporadically? What is the mode of data transfer (i.e., are data passed from one component to another or are data available globally to be shared among system components)? Do data components (e.g., a blackboard or repository) exist, and if so, what is their role? How do functional components interact with data components? Are data components passive or active (i.e., does the data component actively interact with other components in the system)? How do data and control interact within the system?

## Architectural design

- As architectural design begins, the software to be developed must be put into context—that is, the design should define the external entities (other systems, devices, people) that the software interacts with and the nature of the interaction.
  1. Represent the system in context
  2. Define archetypes
  3. Refine the architecture into components
  4. Describe instantiations of the system

### 1. Represent the System in Context

- Use an architectural context diagram (ACD) that shows
  - The identification and flow of all information into and out of a system
  - The specification of all interfaces
  - Any relevant support processing from/by other systems
- An ACD models the manner in which software interacts with entities external to its boundaries

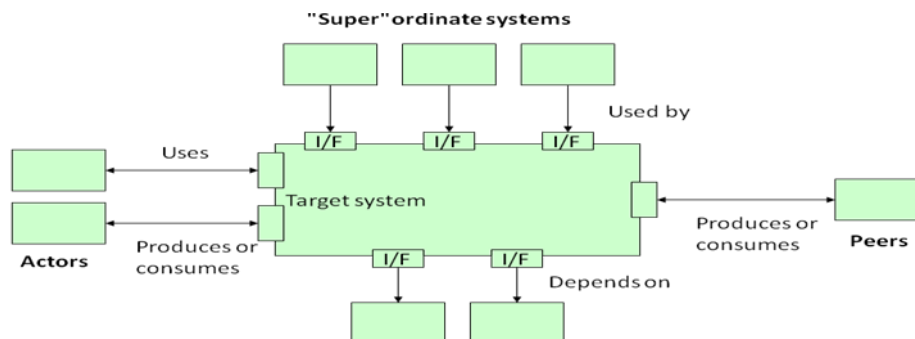

- An ACD identifies systems that interoperate with the target system
  - Super-ordinate systems
    - Use target system as part of some higher level processing scheme
  - Sub-ordinate systems
    - those systems that are used by the target system and provide data or processing that are necessary to complete target system functionality
  - Peer-level systems
    - Interact on a peer-to-peer basis with target system to produced or consumed by peers and target system

- **Actors**
  - **People or devices that interact with target system to produce or consume data**

## **2. Define Archetypes**

- **Archetypes indicate the important abstractions within the problem domain (i.e., they model information)**
- **An archetype is a class or pattern that represents a core abstraction that is critical to the design of an architecture for the target system**
- **Only a relatively small set of archetypes is required in order to design even relatively complex systems**
- **The target system architecture is composed of these archetypes**
  - **They represent stable elements of the architecture**
  - **They may be instantiated in different ways based on the behavior of the system**
  - **They can be derived from the analysis class model**
- **The archetypes and their relationships can be illustrated in a UML class diagram**

### **Archetypes in Software Architecture**

- **Node - Represents a cohesive collection of input and output elements of the home security function**
- **Detector/Sensor - An abstraction that encompasses all sensing equipment that feeds information into the target system.**
- **Indicator - An abstraction that represents all mechanisms (e.g., alarm siren, flashing lights, bell) for indicating that an alarm condition is occurring.**
- **Controller - An abstraction that depicts the mechanism that allows the arming or disarming of a node. If controllers reside on a network, they have the ability to communicate with one another.**

## Archetypes – their attributes

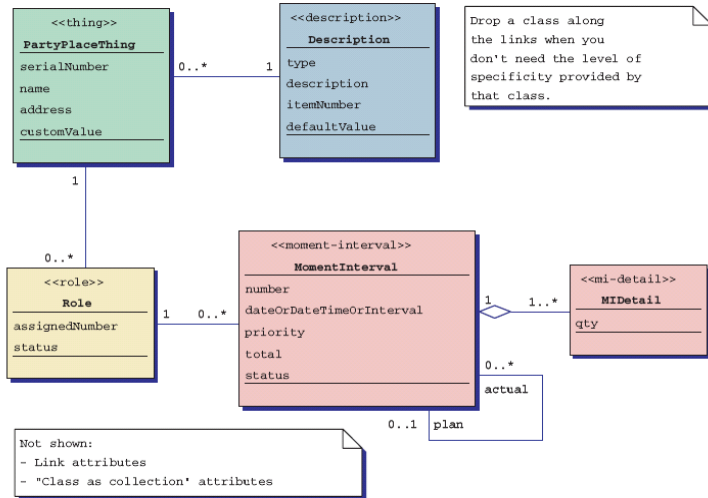

## Archetypes – their methods

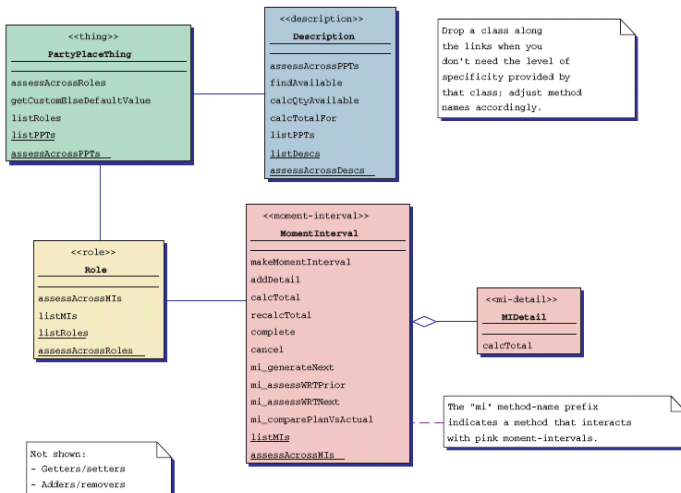

### 3. Refine the Architecture into Components

- Based on the archetypes, the architectural designer refines the software architecture into components to illustrate the overall structure and architectural style of the system
- These components are derived from various sources
  - The application domain provides application components, which are the domain classes in the analysis model that represent entities in the real world
  - The infrastructure domain provides design components (i.e., design classes) that enable application components but have no business connection



- **Examples: memory management, communication, database, and task management**
- **These components are derived from various sources**
  - **The interfaces in the ACD imply one or more specialized components that process the data that flow across the interface**

### **Refine the Architecture into Components**

- **Based on the archetypes, the architectural designer refines the software architecture into components to illustrate the overall structure and architectural style of the system**
- **These components are derived from various sources**
  - **The application domain provides application components, which are the domain classes in the analysis model that represent entities in the real world**
  - **The infrastructure domain provides design components (i.e., design classes) that enable application components but have no business connection**
    - **Examples: memory management, communication, database, and task management**
- **These components are derived from various sources**
  - **The interfaces in the ACD imply one or more specialized components that process the data that flow across the interface**

### **4. Describe Instantiations of the System**

- **The architectural design that has been modeled to this point is still relatively high level.**
- **The context of the system has been represented, archetypes that indicate the important abstractions within the problem domain have been defined, the overall structure of the system is apparent, and the major software components have been identified.**
- **However, further refinement (recall that all design is iterative) is still necessary.**

### Assessing alternative architectural design:

- Design results in a number of architectural alternatives that are each assessed to determine which is the most appropriate for the problem to be solved.

#### **1. An Architecture Trade-Off Analysis Method**

The Software Engineering Institute (SEI) has developed an architecture trade-off analysis method that establishes an iterative evaluation process for software architectures. The design analysis activities that follow are performed iteratively:

- Collect scenarios. A set of use cases is developed to represent the system from the user's point of view.
- Elicit requirements, constraints, and environment description. This information is determined as part of requirements engineering and is used to be certain that all stakeholder concerns have been addressed.
- Describe the architectural styles/patterns that have been chosen to address the scenarios and requirements.
- Evaluate quality attributes by considering each attribute in isolation.
- Identify the sensitivity of quality attributes to various architectural attributes for a specific architectural style.
- Critique candidate architectures (developed in step 3) using the sensitivity analysis conducted.

#### **2. Architectural Complexity**

A useful technique for assessing the overall complexity of a proposed architecture is to consider dependencies between components within the architecture. These dependencies are driven by information/control flow within the system.

#### **3. Architectural Description Languages**

- Architectural description language (ADL) provides a semantics and syntax for describing software architecture.
- ADL should provide the designer with the ability to decompose architectural components, compose individual components into larger architectural blocks, and represent interfaces (connection mechanisms) between components.
- Once descriptive, language based techniques for architectural design has been established; it is more likely that effective assessment methods for architectures will be established as the design evolves.

## Architectural Mapping using Data Flow

- Transform mapping is a set of design steps that allows a DFD with transform flow characteristics to be mapped into a specific architectural style.
  - Information must enter and exit software in an “external world”. Such externalized data must be converted into an internal form for processing. Information enters along paths that transform external data into an internal form. These paths are identified as *Incoming flow*.
  - Incoming data are transformed through a transform center and move along the paths that now lead “out” of the software. Data moving along these paths are called *Outgoing flow*.
- **Transaction Flow**
  - Information flow is often characterized by a single data item, called *transaction*, that triggers other data flow along one of many paths
  - Transaction flow is characterized by data moving along an incoming path that converts external world information into a transaction
  - The transaction is evaluated and, based on its value, flow along one of many action paths is initiated. The hub of information from which many action paths emanate is called a *transaction center*

Flow Characteristics

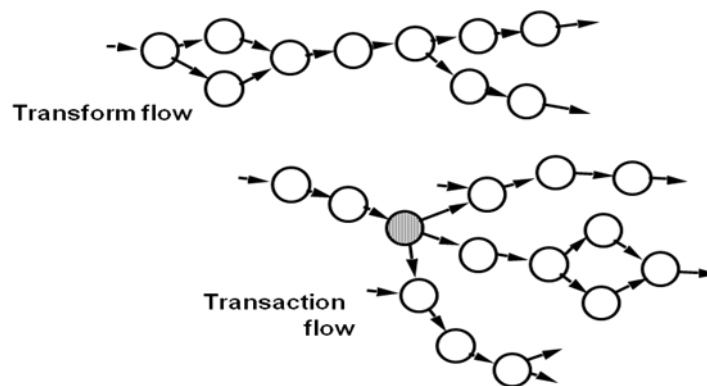

## **Transform Mapping**

1. Review the fundamental system model.
2. Review and refine data flow diagrams for the software
3. Determine whether the DFD has transform or transaction flow characteristics.
4. Isolate the transform center by specifying incoming and outgoing flow boundaries.
5. Perform “first-level factoring”
6. Perform “second-level factoring”
7. Refine the first-iteration architecture using design heuristics for improved software quality.

### Transform Mapping

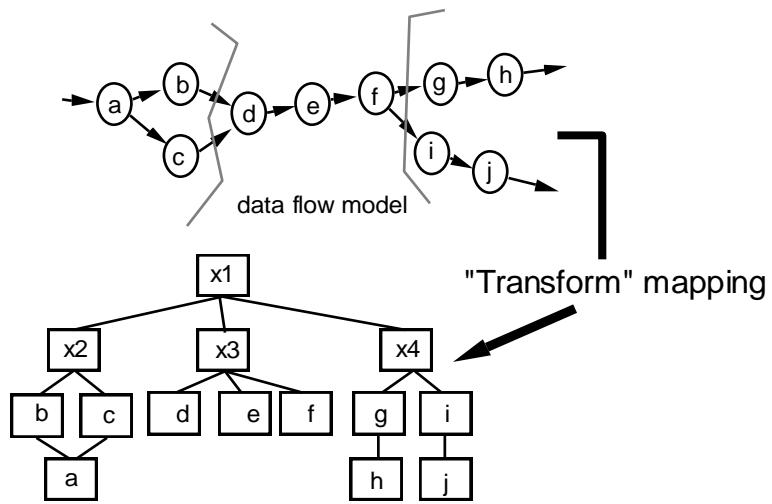

### Factoring

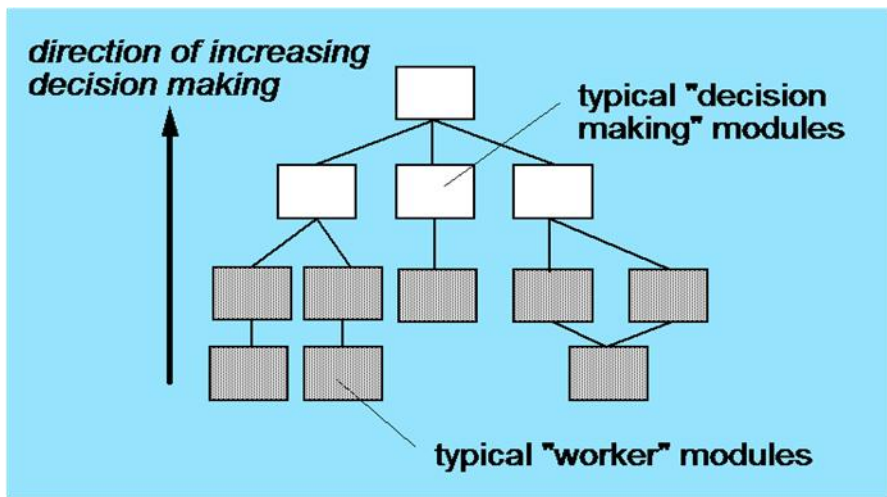

## First Level Factoring

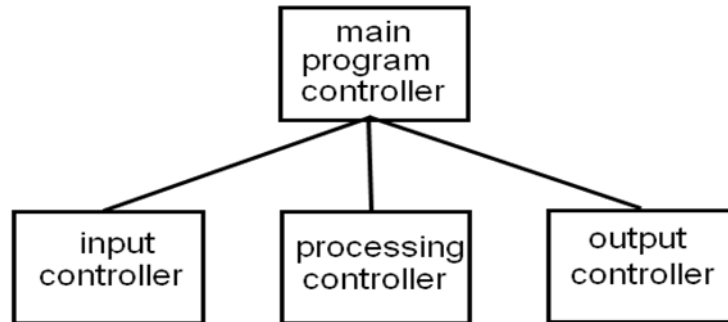

## Second Level Factoring

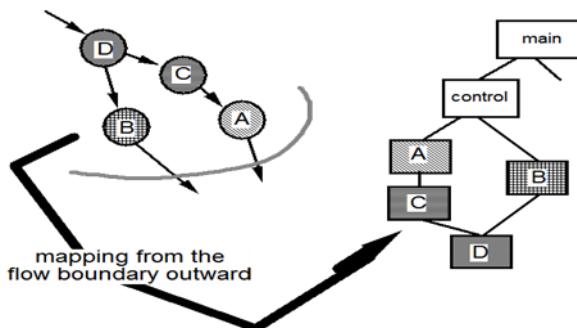

## Transaction Mapping

1. Review the fundamental system model.
2. Review and refine data flow diagrams for the software
3. Determine whether the DFD has transform or transaction flow characteristics.
4. Isolate the transaction center and the flow characteristics along each of the action paths.
5. Map the DFD in a program structure amenable to transaction processing.
6. Factor and refine the transaction structure and the structure of each action path.
7. Refine the first-iteration architecture using design heuristics for improved software quality.

### Transaction Mapping

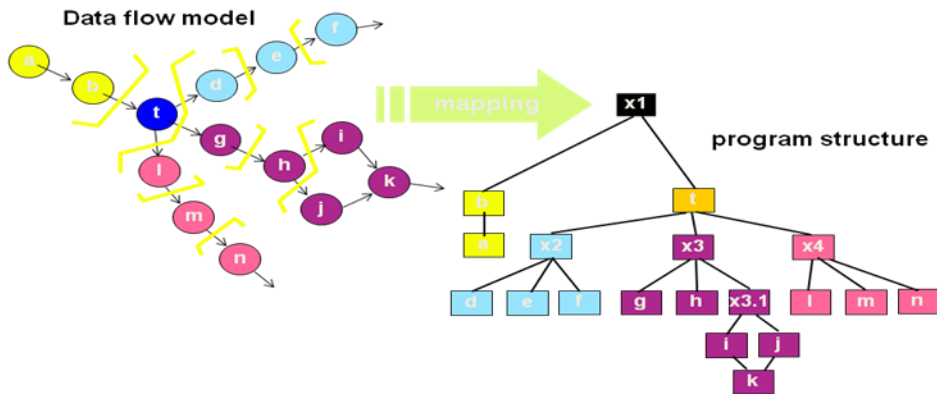

### Isolate Flow Paths

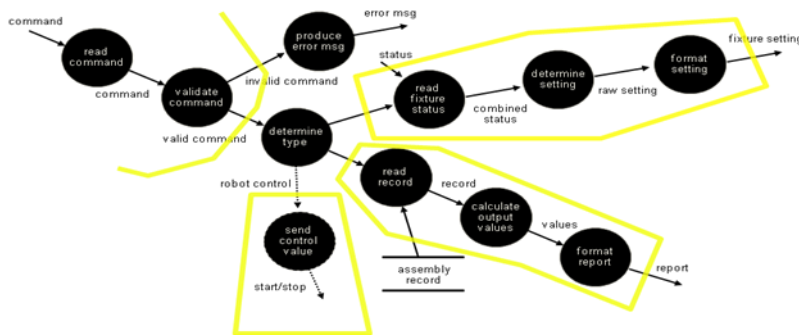

### Map the Flow Model

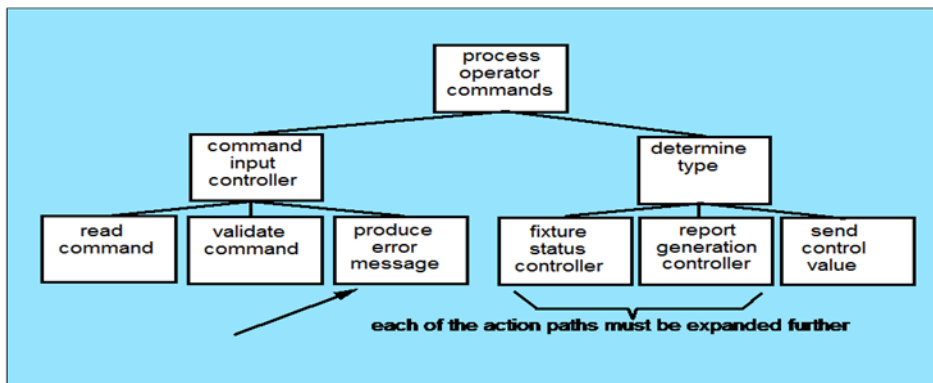

## Refining

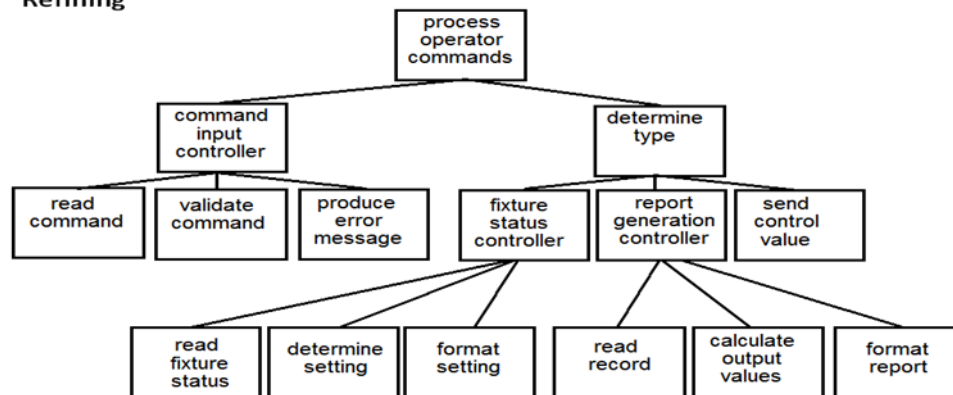

## 2. Refining the Architectural Design

- Any discussion of design refinement should be prefaced with the following comment:
- “Remember that an ‘optimal design’ that doesn’t work has questionable merit.”
- You should be concerned with developing a representation of software that will meet all functional and performance requirements and merit acceptance based on design measures and heuristics.
- Refinement of software architecture during early stages of design is to be encouraged.

## Interface Analysis

### ➤ Interface Analysis:

1. User Analysis
2. Task Analysis and Modeling
3. Analysis of Display Content
4. Analysis of the Work Environment

A key tenet of all software engineering process models is this: *understand the problem before you attempt to design a solution.*

In the case of user interface design, understanding the problem means understanding:

- (1) the people (end users) who will interact with the system through the interface
- (2) the tasks that end users must perform to do their work
- (3) the content that is presented as part of the interface
- (4) the environment in which these tasks will be conducted

### 1. User Analysis:

- The phrase “user interface” is probably all the justification needed to spend some time understanding the user before worrying about technical matters.
- Each User mental image of the software that may be different from the mental image developed by other users.

- The user's mental image may be vastly different from the software engineer's design model.

**Information from a broad array of sources can be used to accomplish this:**

- User Interviews
- Sales input
- Marketing input
- Support input

**2. Task Analysis and Modeling:**

The goal of task analysis is to answer the following questions:

- What work will the user perform in specific circumstances?
- What tasks and subtasks will be performed as the user does the work?
- What specific problem domain objects will the user manipulate as work is performed?
- What is the sequence of work tasks—the workflow?
- What is the hierarchy of tasks?

**Techniques that are applied to the user interface**

- Use cases
- Task elaboration
- Object elaboration
- Workflow analysis
- Hierarchical representation
  - Key interface characteristics:
    1. Each user implements different tasks via the interface; therefore, the look and feel of the interface designed for the patient will be different than the one defined for pharmacists or physicians.
    2. The interface design for pharmacists and physicians must accommodate access to and display of information from secondary information sources (e.g., access to inventory for the pharmacist and access to information about alternative medications for the physician).

**3. Analysis of Display Content**

For modern applications, display content can range from character-based reports (e.g., a spreadsheet), graphical displays (e.g., a histogram, a 3-D model, a picture of a person), or specialized information (e.g., audio or video files).

These data objects may be

- (1) Generated by components (unrelated to the interface) in other parts of an application
- (2) Acquired from data stored in a database that is accessible from the application
- (3) Transmitted from systems external to the application in question.

**How do we determine the format and aesthetics of content displayed as part of the UI?**

1

- Are different types of data assigned to consistent geographic locations on the screen (e.g., photos always appear in the upper right-hand corner)?
- Can the user customize the screen location for content?
- Is proper on-screen identification assigned to all content?



- If a large report is to be presented, how should it be partitioned for ease of understanding?
- Will mechanisms be available for moving directly to summary information for large collections of data?
- Will graphical output be scaled to fit within the bounds of the display device that is used?
- How will color be used to enhance understanding?
- How will error messages and warnings be presented to the user?

The answers to these (and other) questions will help you to establish requirements for content presentation.

## 5. Analysis of the Work Environment

- In some applications the user interface for a computer-based system is placed in a “user-friendly location” (e.g., proper lighting, good display height, easy keyboard access), but in others (e.g., a factory floor or an airplane cockpit), lighting may be suboptimal, noise may be a factor, a keyboard or mouse may not be an option, display placement may be less than ideal.
- The interface designer may be constrained by factors that mitigate against ease of use.
- In addition to physical environmental factors, the workplace culture also comes into play.
- Will system interaction be measured in some manner (e.g., time per transaction or accuracy of a transaction)? Will two or more people have to share information before an input can be provided?
- How will support be provided to users of the system?

## Interface Design Steps

Interface Design Steps:

1. Applying Interface Design Steps
2. User Interface Design Patterns
3. Design Issues

### 1. Applying Interface Design Steps

- The definition of interface objects and the actions that are applied to them is an important step in interface design.
- Once the objects and actions have been defined and elaborated iteratively, they are categorized by type. Target, source, and application objects are identified.
- A *source object* (e.g., a report icon) is dragged and dropped onto a *target object* (e.g., a printer icon).
- An *application object* represents application-specific data that are not directly manipulated as part of screen interaction.
- For example, a mailing list is used to store names for a mailing. The list itself might be sorted, merged, or purged (menu-based actions), but it is not dragged and dropped via user interaction.

## 2. User Interface Design Patterns

- Graphical user interfaces have become so common that a wide variety of user interface design patterns has emerged.
- A design pattern is an abstraction that prescribes a design solution to a specific, well-bounded design problem.
- A vast array of interface design patterns has been proposed over the past decade.

## 3. Design Issues

As the design of a user interface evolves, **four common design** issues almost always surface:

1. System response time
2. User help facilities
3. Error information handling
4. Command labeling

## Designing class based components

### Designing Class Based Components

1. Basic Design Principles
2. Component-Level Design Guidelines
3. Cohesion
4. Coupling

Component-level design focuses on the elaboration of analysis classes (problem domain specific classes) and definition and refinement of infrastructure classes

Purpose of using design principles is to create designs that are more amenable to change and to reduce propagation of side effects when changes do occur

### 1. Basic Design Principles

- Single Responsibility Principle
- Open-Closed Principle
- Liskov Substitution Principle
- Dependency inversion Principle
- Interface segregation Principle

### 2. Component-Level Design Guidelines

In addition to the principles discussed, a set of pragmatic design guidelines can be applied as component-level design proceeds.

These guidelines apply to components, their interfaces, and the dependencies and inheritance and inheritance characteristics that have an impact on the resultant design.

- Components: Naming conventions should be established for components that are specified as part of the architectural model and then refined and elaborated as part of the component-level model.

- **Interfaces:** Interfaces provide important information about communication and collaboration
- **Dependencies and Inheritance:** For improved readability, it is a good idea to model dependencies from left to right and inheritance from bottom (derived classes) to top (base classes).

### 3. Cohesion

- The “single-mindedness” of a component.
- Cohesion implies that a single component or class encapsulates only attributes and operations that are closely related to one another and to the class or component itself.
- Types of cohesion
  - Functional
  - Layer
  - Communicational

### 4. Coupling

- Coupling or Dependency is the degree to which each program module relies on each one of the other modules.
- Coupling is usually contrasted with cohesion. Low coupling often correlates with high cohesion, and vice versa
- Low coupling is often a sign of a well-structured computer system and a good design, and when combined with high cohesion, supports the general goals of high readability and maintainability.

#### Different categories of coupling:

- **Content coupling.** Occurs when one component “surreptitiously modifies data that is internal to another component” [Let01]. This violates information hiding—a basic design concept.
- **Common coupling.** Occurs when a number of components all make use of a global variable. Although this is sometimes necessary (e.g., for establishing default values that are applicable throughout an application), common coupling can lead to uncontrolled error propagation and unforeseen side effects when changes are made.
- **Control coupling.** Occurs when operation A() invokes operation B() and passes a control flag to B. The control flag then “directs” logical flow within B. The problem with this form of coupling is that an unrelated change in B can result in the necessity to change the meaning of the control flag that A passes. If this is overlooked, an error will result. Stamp coupling. Occurs when ClassB is declared as a type for an argument of an operation of ClassA. Because ClassB is now a part of the definition of ClassA, modifying the system becomes more complex.
- **Data coupling.** Occurs when operations pass long strings of data arguments. The “bandwidth” of communication between classes and components grows and the complexity of the interface increases. Testing and maintenance are more difficult.

- **Routine call coupling.** Occurs when one operation invokes another. This level of coupling is common and is often quite necessary. However, it does increase the connectedness of a system.
- **Type use coupling.** Occurs when component A uses a data type defined in component B (e.g., this occurs whenever “a class declares an instance variable or a local variable as having another class for its type” [Let01]). If the type definition changes, every component that uses the definition must also change.
- **Inclusion or import coupling.** Occurs when component A imports or includes a package or the content of component B.
- **External coupling.** Occurs when a component communicates or collaborates with infrastructure components (e.g., operating system functions, database capability, telecommunication functions). Although this type of coupling is necessary, it should be limited to a small number of components or classes within a system.

## Traditional components

### Designing Traditional Components

- Graphical Design Notation
- Tabular Design Notation
- Program Design Language

Conventional design constructs emphasize the maintainability of a functional/procedural program

- Each construct has a predictable logical structure where control enters at the top and exits at the bottom, enabling a maintainer to easily follow the procedural flow
- Various notations depict the use of these constructs
  - Graphical design notation
    - Sequence, if-then-else, selection, repetition
  - Tabular design notation
  - Program design language

### 1. Graphical Design Notation

- ”A picture is worth a thousand words,” but it’s rather important to know which picture and which 1000 words.
- There is no question that graphical tools, such as the UML activity diagram or the flowchart, provide useful pictorial patterns that readily depict procedural detail.
- However, if graphical tools are misused, the wrong picture may lead to the wrong software.
- The activity diagram allows you to represent sequence, condition, and repetition—
- all elements of structured programming—and is a descendent of an earlier pictorial design representation (still used widely) called a flowchart.
- A flowchart, like an activity diagram, is quite simple pictorially. A box is used to indicate a processing step. A diamond represents a logical condition, and arrows show the flow of

control. The sequence is represented as two processing boxes connected by a line (arrow) of control.

## 2. Tabular Design Notation

The following steps are applied to develop a decision table:

1. List all actions that can be associated with a specific procedure (or module)
2. List all conditions (or decisions made) during execution of the procedure
3. Associate specific sets of conditions with specific actions, eliminating impossible combinations of conditions; alternatively, develop every possible permutation of conditions
4. Define rules by indicating what action(s) occurs for a set of conditions.

## 3. Program Design Language

- Program design language (PDL), also called structured English or pseudocode, incorporates the logical structure of a programming language with the free-form expressive ability of a natural language (e.g., English).
- Narrative text (e.g., English) is embedded within a programming language-like syntax. Automated tools (e.g., [Cai03]) can be used to enhance the application of PDL.
- A basic PDL syntax should include constructs for component definition, interface description, data declaration, block structuring, condition constructs, repetition constructs, and input-output (I/O) constructs.
- PDL can be extended to include keywords for multitasking and/or concurrent processing, interrupt handling, interprocess synchronization, and many other features.

**UNIT- IV: Testing and Implementation : Software testing fundamentals: Internal and external views of testing, white box testing, basis path testing, control structure testing, black box testing, regression testing, unit testing, integration testing, validation testing, system testing and debugging; Software implementation techniques: Coding practices, refactoring.**

### Software Testing Fundamentals

The goal of testing is to find errors, and a good test is one that has a high probability of finding an error. Therefore, you should design and implement a computer based system or a product with “testability” in mind. At the same time, the tests themselves must exhibit a set of characteristics that achieve the goal of finding the most errors with a minimum of effort.

**Testability.** James provides the following definition for testability: “Software testability is simply how easily [a computer program] can be tested.” The following characteristics lead to testable software.

**Operability.** “The better it works, the more efficiently it can be tested.” If a system is designed and implemented with quality in mind, relatively few bugs will block the execution of tests, allowing testing to progress without fits and starts.

**Observability.** “What you see is what you test.” Inputs provided as part of testing produce distinct outputs. System states and variables are visible or queryable during execution. Incorrect output is easily identified. Internal errors are automatically detected and reported. Source code is accessible.

**Controllability.** “The better we can control the software, the more the testing can be automated and optimized.” All possible outputs can be generated through some combination of input, and I/O formats are consistent and structured. All code is executable through some combination of input. Software and hardware states and variables can be controlled directly by the test engineer. Tests can be conveniently specified, automated, and reproduced.

**Decomposability.** “By controlling the scope of testing, we can more quickly isolate problems and perform smarter retesting.” The software system is built from independent modules that can be tested independently.

**Simplicity.** “The less there is to test, the more quickly we can test it.” The program should exhibit functional simplicity (e.g., the feature set is the minimum necessary to meet requirements); structural simplicity (e.g., architecture is modularized to limit the propagation of faults), and code simplicity (e.g., a coding standard is adopted for ease of inspection and maintenance).

**Stability.** “The fewer the changes, the fewer the disruptions to testing.” Changes to the software are infrequent, controlled when they do occur, and do not invalidate existing tests. The software recovers well from failures.

**Understandability.** “The more information we have, the smarter we will test.” The architectural design and the dependencies between internal, external, and shared components are well understood. Technical documentation is instantly accessible, well organized, specific and detailed, and accurate. Changes to the design are communicated to testers.

## What is a good Test?

Test Characteristics. And what about the tests themselves? Kaner, Falk, and Nguyen [Kan93] suggest the following attributes of a “good” test:

A good test has a high probability of finding an error. To achieve this goal, the tester must understand the software and attempt to develop a mental picture of how the software might fail. Ideally, the classes of failure are probed. For example, one class of potential failure in a graphical user interface is the failure to recognize proper mouse position. A set of tests would be designed to exercise the mouse in an attempt to demonstrate an error in mouse position recognition.

A good test is not redundant. Testing time and resources are limited. There is no point in conducting a test that has the same purpose as another test. Every test should have a different purpose (even if it is subtly different).

A good test should be “best of breed” [Kan93]. In a group of tests that have a similar intent, time and resource limitations may mitigate toward the execution of only a subset of these tests. In such cases, the test that has the highest likelihood of uncovering a whole class of errors should be used.

A good test should be neither too simple nor too complex. Although it is sometimes possible to combine a series of tests into one test case, the possible side effects associated with this approach may mask errors. In general, each test should be executed separately.

## Internal and External Views of Testing

- Any engineered product (and most other things) can be tested in one of two ways:
  - (1) Knowing the specified function that a product has been designed to perform, tests can be conducted that demonstrate each function is fully operational while at the same time searching for errors in each function.
  - (2) Knowing the internal workings of a product, tests can be conducted to ensure that “all gears mesh,” that is, internal operations are performed according to specifications and all internal components have been adequately exercised.
- The first test approach takes an external view and is called black-box testing. The second requires an internal view and is termed white-box testing.
- Black-box testing alludes to tests that are conducted at the software interface. A black-box test examines some fundamental aspect of a system with little regard for the internal logical structure of the software.
- White-box testing of software is predicated on close examination of procedural detail. Logical paths through the software and collaborations between components are tested by exercising specific sets of conditions and/or loops.
- White-box testing would lead to “100 percent correct programs.” need do is define all logical paths, develop test cases to exercise them, and evaluate results, i.e, generate test cases to exercise program logic exhaustively.
- A limited number of important logical paths can be selected and exercised. Important data structures can be probed for validity.

## White Box Testing

- White-box testing is the detailed investigation of internal logic and structure of the code.
- White-box testing, sometimes called glass-box testing or open-box testing.
- It is a test-case design philosophy that uses the control structure described as part of component-level design to derive test cases.
- The tester needs to have a look inside the source code and find out which unit/chunk of the code is behaving inappropriately.
- Using White-box testing methods, you can derive test cases that
  - (1) Guarantee that all independent paths within a module have been exercised at least once,
  - (2) Exercise all logical decisions on their true and false sides,
  - (3) Execute all loops at their boundaries and within their operational bounds, and
  - (4) Exercise internal data structures to ensure their validity.

Advantages	Disadvantages
As the tester has knowledge of the source code, it becomes very easy to find out which type of data can help in testing the application effectively	Due to the fact that a skilled tester is needed to perform white-box testing, the costs are increased.
It helps in optimizing the code.	Sometimes it is impossible to look into every nook and corner to find out hidden errors that may create problems, as many paths will go untested.
Extra lines of code can be removed which can bring in hidden defects.	It is difficult to maintain white-box testing, as it requires specialized tools like code analyzers and debugging tools.
Due to the tester's knowledge about the code, maximum coverage is attained during test scenario writing.	



## Basis Path Testing:

- Basis path testing is a white-box testing technique.
  - The basis path method enables the test-case designer to derive a logical complexity measure of a procedural design and use this measure as a guide for defining a basis set of execution paths.
  - Test cases derived to exercise the basis set are guaranteed to execute every statement in the program at least one time during testing.
- ✓ Flow Graph Notation
  - ✓ Independent Program Paths
  - ✓ Deriving Test Cases
  - ✓ Graph Matrices

### 1. Flow Graph Notation

- A simple notation for the representation of control flow, called a flow graph (or program graph).
- The flow graph depicts logical control flow using the notation in the following figure.
- Arrows called edges represent flow of control
- Circles called nodes represent one or more actions.
- Areas bounded by edges and nodes called regions.
- A predicate node is a node containing a condition.
- Any procedural design can be translated into a flow graph.
- Note that compound Boolean expressions at tests generate at least two predicate node and additional arcs.

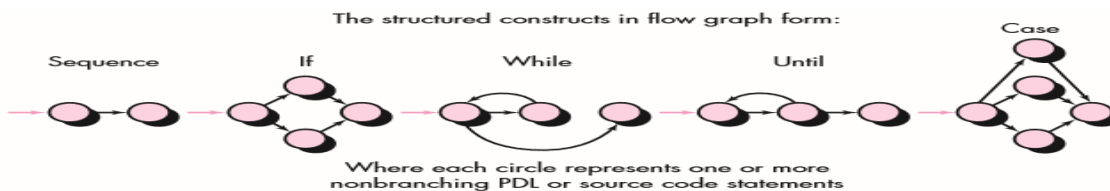

- To illustrate the use of a flow graph, consider the procedural design representation in Figure.
- Here, Figure (a) flow chart is used to depict program control structure.
- Figure(b) maps the flowchart into a corresponding flow graph (assuming that no compound conditions are contained in the decision diamonds of the flowchart).
- Figure(b), each circle, called a flow graph node, represents one or more procedural statements.
- A sequence of process boxes and a decision diamond can map into a single node.
- The arrows on the flow graph, called edges or links, represent flow of control and are analogous to flowchart arrows.
- An edge must terminate at a node, even if the node does not represent any procedural statements (e.g., see the flow graph symbol for the if-then-else construct).
- Areas bounded by edges and nodes are called regions. When counting regions.

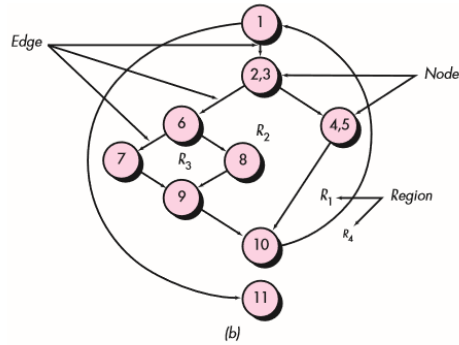
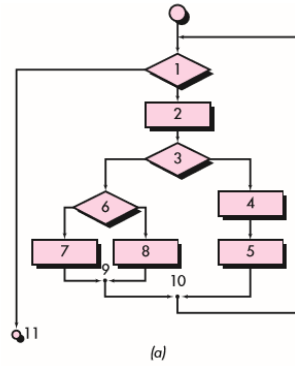

## 2. Independent Program Paths

- An independent path is any path through the program that introduces at least one new set of processing statements or a new condition.
- Cyclomatic complexity is software metric that provides a quantitative measure of the logical complexity of a program.
- When used in the context of the basis path testing method, the value computed for Cyclomatic complexity defines the number of independent paths in the basis set of a program and provides you with an upper bound for the number of tests that must be conducted to ensure that all statements have been executed at least once.
- Cyclomatic complexity has a foundation in graph theory and provides you with an extremely useful software metric. Complexity is computed in one of three ways:
  1. The number of regions of the flow graph corresponds to the Cyclomatic complexity.
  2. Cyclomatic complexity  $V(G)$  for a flow graph  $G$  is defined as  $V(G) = E - N + 2$  where  $E$  is the number of flow graph edges and  $N$  is the number of flow graph nodes.
  3. Cyclomatic complexity  $V(G)$  for a flow graph  $G$  is also defined as  $V(G) = P + 1$  where  $P$  is the number of predicate nodes contained in the flow graph  $G$ .

### 3. Deriving Test Cases

The following steps can be applied to derive the basis set:

1. Using the design or code as a foundation, draw a corresponding flow graph.
2. Determine the Cyclomatic complexity of the resultant flow graph.
3. Determine a basis set of linearly independent paths.
4. Prepare test cases that will force execution of each path in the basis set.

### 4. Graph Matrices:

- A data structure, called a graph matrix, can be quite useful for developing a software tool that assists in basis path testing.
- A graph matrix is a square matrix whose size (i.e., number of rows and columns) is equal to the number of nodes on the flow graph.

- Each row and column corresponds to an identified node, and matrix entries correspond to connections (an edge) between nodes.
- A simple example of a flow graph and its corresponding graph matrix is shown in Figure.
- Referring to the figure, each node on the flow graph is identified by numbers, while each edge is identified by letters.
- A letter entry is made in the matrix to correspond to a connection between two nodes. For example, node 3 is connected to node 4 by edge b.
- The graph matrix is nothing more than a tabular representation of a flow graph.
- By adding a link weight to each matrix entry, the graph matrix can become a powerful tool for evaluating program control structure during testing.
- The link weight provides additional information about control flow. In its simplest form, the link weight is 1 (a connection exists) or 0 (a connection does not exist).

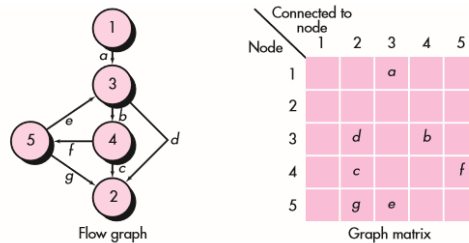

### Control Structure Testing:

- Although basis path testing is simple and highly effective, it is not sufficient in itself.
- Other variations on control structure testing necessary. These broaden testing coverage and improve the quality of white-box testing.

#### 1. Condition testing:

- Condition testing is a test-case design method that exercises the logical conditions contained in a program module.
- A simple condition is a Boolean variable or a relational expression, possibly preceded with one NOT ( $\neg$ ) operator.
- A relational expression takes the form
 
$$E1 \langle \text{relational-operator} \rangle E2$$
- Where E1 and E2 are arithmetic expressions and  $\langle \text{relational-operator} \rangle$  is one of the following:
- A compound condition is composed of two or more simple conditions, Boolean operators, and parentheses.
- The condition testing method focuses on testing each condition in the program to ensure that it does not contain errors.

## 2. Data Flow Testing

- The data flow testing method selects test paths of a program according to the locations of definitions and uses of variables in the program. T
- To illustrate the data flow testing approach, assume that each statement in a program is assigned a unique statement number and that each function does not modify its parameters or global variables.
- For a statement with S as its statement number,
- $DEF(S) = \{X \mid \text{statement } S \text{ contains a definition of } X\}$
- $USE(S) = \{X \mid \text{statement } S \text{ contains a use of } X\}$
- If statement S is an if or loop statement, its DEF set is empty and its USE set is based on the condition of statement S. The definition of variable X at statement S is said to be live at statement S' if there exists a path from statement S to statement S' that contains no other definition of X.

## 3. Loop Testing

- Loops are the cornerstone for the vast majority of all algorithms implemented in software.
- Loop testing is a white-box testing technique that focuses exclusively on the validity of loop constructs.
- Four different classes of loops can be defined:

1. **Simple loops:** The following set of tests can be applied to simple loops, where n is the maximum number of allowable passes through the loop.

1. Skip the loop entirely.

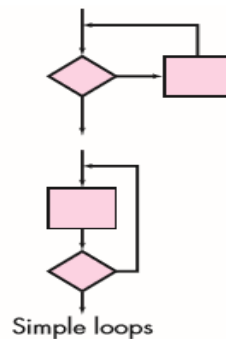

2. Only one pass through the loop.
3. Two passes through the loop.
4. m passes through the loop where  $m < n$ .
5.  $n - 1$ ,  $n$ ,  $n + 1$  passes through the loop.

2. **Nested loops:** If we were to extend the test approach for simple loops to nested loops, the number of possible tests would grow geometrically as the level of nesting increases.
  - Beizer suggests an approach that will help to reduce the number of tests:
  -

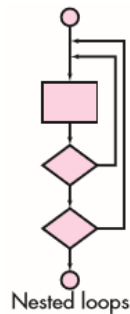

1. Start at the innermost loop. Set all other loops to minimum values.
2. Conduct simple loop tests for the innermost loop while holding the outer loops at their minimum iteration parameter (e.g., loop counter) values. Add other tests for out-of-range or excluded values.
3. Work outward, conducting tests for the next loop, but keeping all other outer loops at minimum values and other nested loops to “typical” values.
4. Continue until all loops have been tested.

3. **Concatenated loops:** In the concatenated loops, if two loops are independent of each other then they are tested using simple loops or else test them as nested loops. However if the loop counter for one loop is used as the initial value for the others, then it will not be considered as an independent loops.

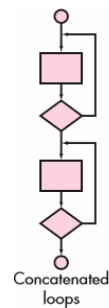

4. **Unstructured loops:** Whenever possible, this class of loops should be redesigned to reflect the use of the structured programming constructs.

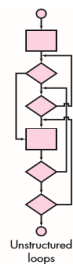

## Black Box Testing

- Black-box testing, also called behavioral testing.
- It focuses on the functional requirements of the software.
- Black-box testing techniques enable you to derive sets of input conditions that will fully exercise all functional requirements for a program.
- Black-box testing attempts to find errors in the following categories:
  - (1) incorrect or missing functions
  - (2) interface errors
  - (3) errors in data structures or external database access
  - (4) behavior or performance errors
  - (5) initialization and termination errors.

### Black – Box Testing Techniques

1. Graph-Based Testing Methods
3. Boundary Value Analysis

2. Equivalence Partitioning
4. Orthogonal Array Testing

#### 1. Graph-Based Testing Methods

- The first step in black-box testing is to understand the objects<sup>5</sup> that are modeled in software and the relationships that connect these objects.
- Next step is to define a series of tests that verify “all objects have the expected relationship to one another.
- To accomplish these steps, create a **graph**—a collection of nodes that represent objects, **links** that represent the relationships between objects, **node weights** that describe the properties of a node (e.g., a specific data value or state behavior), and **link weights** that describe some characteristic of a link.
- The symbolic representation of a graph is shown in below Figure.
- **Nodes** are represented as circles connected by links that take a number of different forms.
- A **directed link** (represented by an arrow) indicates that a relationship moves in only one direction.
- A **bidirectional link**, also called a symmetric link, implies that the relationship applies in both directions.
- **Parallel links** are used when a number of different relationships are established between graph nodes.

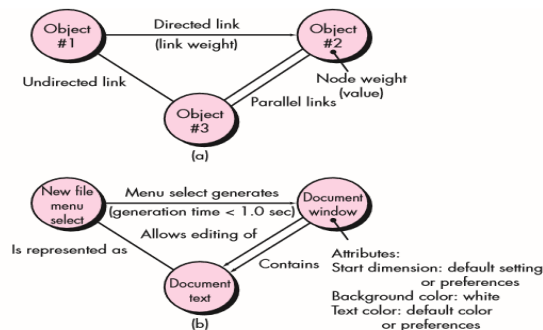

## 2. Equivalence Partitioning

- Equivalence partitioning is a black-box testing method that divides the input domain of a program into classes of data from which test cases can be derived.
- Test-case design for equivalence partitioning is based on an evaluation of equivalence classes for an input condition.
- Equivalence classes may be defined according to the following guidelines:
  - ❖ If an input condition specifies a range, one valid and two invalid equivalence classes are defined.
  - ❖ If an input condition requires a specific value, one valid and two invalid equivalence classes are defined.
  - ❖ If an input condition specifies a member of a set, one valid and one invalid equivalence class are defined.
  - ❖ If an input condition is Boolean, one valid and one invalid class are defined.

## 3. Boundary Value Analysis

- A greater number of errors occurs at the boundaries of the input domain rather than in the “center of input domain.
  - For this reason that boundary value analysis (BVA) has been developed as a testing technique
  - Boundary value analysis leads to a selection of test cases that exercise bounding values.
  - BVA leads to the selection of test cases at the “edges” of the class. Rather than focusing solely on input conditions.
  - BVA derives test cases from the output domain also.
  - Guidelines for BVA are similar in many respects to those provided for equivalence partitioning:
1. If an input condition specifies a range bounded by values a and b, test cases should be designed with values a and b and just above and just below a and b.
  2. If an input condition specifies a number of values, test cases should be developed that exercise the minimum and maximum numbers. Values just above and below minimum and maximum are also tested.
  3. Apply guidelines 1 and 2 to out put conditions. For example, assume that a temperature versus pressure table is required as output from an engineering analysis program. Test cases should be designed to create an output report that produces the maximum(and minimum)allowable number of table entries.
  4. If internal program data structures have prescribed boundaries (e.g., a table has a defined limit of 100 entries), be certain to design a test case to exercise the data structure at its boundary. Most software engineers intuitively perform BVA to some degree. By applying these guidelines, boundary testing will be more complete, thereby having a higher likelihood for error detection.

#### 4. Orthogonal Array Testing

- Orthogonal array testing can be applied to problems in which the input domain is relatively small but too large to accommodate exhaustive testing.
- The orthogonal array testing method is particularly useful in finding **region faults**—an error category associated with faulty logic within a software compone
- **For example**, when a train ticket has to be verified, the factors such as - the number of passengers, ticket number, seat numbers and the train numbers has to be tested, which becomes difficult when a tester verifies input one by one. Hence, it will be more efficient when he combines more inputs together and does testing. Here, use the Orthogonal Array testing method.
- When orthogonal array testing occurs, an **L9 orthogonal array** of test cases is created.
- The L9 orthogonal array has a “balancing property”.
- That is, test cases (represented by dark dots in the figure) are “dispersed uniformly throughout the test domain,” as illustrated in the right-hand cube in Figure.

Test case	Test parameters			
	P1	P2	P3	P4
1	1	1	1	1
2	1	2	2	2
3	1	3	3	3
4	2	1	2	3
5	2	2	3	1
6	2	3	1	2
7	3	1	3	2
8	3	2	1	3
9	3	3	2	1

- To illustrate the use of the L9 orthogonal array, consider the send function for a fax application.
- Four parameters, P1, P2, P3, and P4, are passed to the send function. Each takes on three discrete values. For example, P1 takes on values:
  - P1 = 1, send it now : P1 = 2, send it one hour later : P1 = 3, send it after midnight
- P2, P3, and P4 would also take on values of 1, 2, and 3, signifying other send functions.
- If a “one input item at a time” testing strategy were chosen, the following sequence of tests (P1,P2,P3,P4) would be specified: (1,1,1,1),(2,1,1,1),(3,1,1,1), (1, 2, 1, 1), (1, 3, 1, 1), (1, 1, 2, 1), (1, 1, 3, 1), (1, 1, 1, 2), and (1, 1, 1, 3).
- The orthogonal array testing approach enables you to provide good test coverage with far fewer test cases than the exhaustive strategy. An L9 orthogonal array for the fax send function is illustrated in Figure.



## Regression testing

- When any modification or changes are done to the application or even when any small change is done to the code then it can bring unexpected issues. Along with the new changes it becomes very important to test whether the existing functionality is intact or not. This can be achieved by doing the **regression testing**.
- The purpose of the regression testing is to find the bugs which may get introduced accidentally because of the new changes or modification.
- During confirmation testing the defect got fixed and that part of the application started working as intended. But there might be a possibility that the fix may have introduced or uncovered a different defect elsewhere in the software. The way to detect these ‘**unexpected side-effects**’ of fixes is to do regression testing.
- This also ensures that the bugs found earlier are NOT creatable.
- Usually the regression testing is done by automation tools because in order to fix the defect the same test is carried out again and again and it will be very tedious and time consuming to do it manually.
- During regression testing the test cases are prioritized depending upon the changes done to the feature or module in the application. The feature or module where the changes or modification is done that entire feature is taken into priority for testing.
- This testing becomes very important when there are continuous modifications or enhancements done in the application or product. These changes or enhancements should NOT introduce new issues in the existing tested code.
- This helps in maintaining the quality of the product along with the new changes in the application.
- **Example:**

Let’s assume that there is an application which maintains the details of all the students in school. This application has four buttons Add, Save, Delete and Refresh. All the buttons functionalities are working as expected. Recently a new button ‘Update’ is added in the application. This ‘Update’ button functionality is tested and confirmed that it’s working as expected. But at the same time it becomes very important to know that the introduction of this new button should not impact the other existing buttons functionality. Along with the ‘Update’ button all the other buttons functionality are tested in order to find any new issues in the existing code. This process is known as regression testing.

### **When to use Regression testing it:**

1. Any new feature is added
2. Any enhancement is done
3. Any bug is fixed
4. Any performance related issue is fixed

### **Advantages of Regression testing:**

- It helps us to make sure that any changes like bug fixes or any enhancements to the module or application have not impacted the existing tested code.
- It ensures that the bugs found earlier are NOT creatable.
- Regression testing can be done by using the automation tools
- It helps in improving the quality of the product.

## Disadvantages of Regression testing:

- If regression testing is done without using automated tools then it can be very tedious and time consuming because here we execute the same set of test cases again and again.
- Regression test is required even when a very small change is done in the code because this small modification can bring unexpected issues in the existing functionality.

## Unit testing

- Unit testing focuses verification effort on the smallest unit of software design—the software component or module
- Targets for Unit Test Cases
  - Module interface
    - Ensure that information flows properly into and out of the module
  - Local data structures
    - Ensure that data stored temporarily maintains its integrity during all steps in an algorithm execution
  - Boundary conditions
    - Ensure that the module operates properly at boundary values established to limit or restrict processing
  - Independent paths (basis paths)
    - Paths are exercised to ensure that all statements in a module have been executed at least once
  - Error handling paths
    - Ensure that the algorithms respond correctly to specific error conditions
- **Targets for Unit Test Cases**

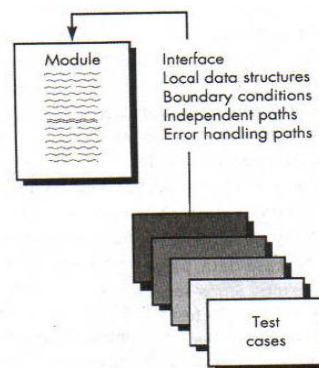

- Common Computational Errors in Execution Paths
  - Misunderstood or incorrect arithmetic precedence
  - Mixed mode operations (e.g., int, float, char)
  - Incorrect initialization of values

- Precision inaccuracy and round-off errors
  - Incorrect symbolic representation of an expression (int vs. float)
- Other Errors to Uncover
  - Comparison of different data types
  - Incorrect logical operators or precedence
  - Expectation of equality when precision error makes equality unlikely (using == with float types)
  - Incorrect comparison of variables
  - Improper or nonexistent loop termination
  - Failure to exit when divergent iteration is encountered
  - Improperly modified loop variables
  - Boundary value violations
- Problems to uncover in Error Handling
  - Error description is unintelligible or ambiguous
  - Error noted does not correspond to error encountered
  - Error condition causes operating system intervention prior to error handling
  - Exception condition processing is incorrect
  - Error description does not provide enough information to assist in the location of the cause of the error
- Unit test procedures
  - Because a component is not a stand-alone program, driver and / or stub software must be developed for each unit test.
- Driver
  - A simple main program that accepts test case data, passes such data to the component being tested, and prints the returned results
- Stubs
  - Serve to replace modules that are subordinate to (called by) the component to be tested
  - It uses the module's exact interface, may do minimal data manipulation, provides verification of entry, and returns control to the module undergoing testing.
- Drivers and stubs both represent overhead
  - Both must be written but don't constitute part of the installed software products.

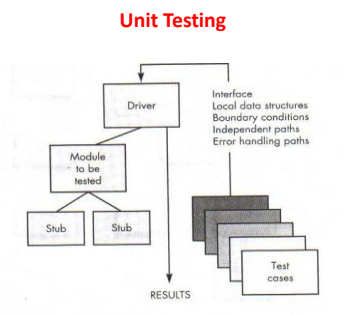

## Integration Testing

Integration testing is systematic technique for constructing the software architecture while at the same time conducting tests to cover to uncover errors associated with interfacing

- Objective is to take unit tested modules and build a program structure based on the prescribed design
- Two Approaches
  - Non-incremental Integration Testing
  - Incremental Integration Testing
- Non-incremental Integration Testing
  - Commonly called the “Big Bang” approach
  - All components are combined in advance
  - The entire program is tested as a whole
  - Disadvantages
    - Chaos results
    - Many seemingly-unrelated errors are encountered
    - Correction is difficult because isolation of causes is complicated
    - Once a set of errors are corrected, more errors occur, and testing appears to enter an endless loop
- Incremental Integration Testing
  - Three kinds
    - Top-down integration
    - Bottom-up integration
    - Sandwich integration
  - The program is constructed and tested in small increments
  - Errors are easier to isolate and correct
  - Interfaces are more likely to be tested completely
  - A systematic test approach is applied
- Top-down Integration
  - Modules are integrated by moving downward through the control hierarchy, beginning with the main module
  - Subordinate modules are incorporated in either a depth-first or breadth-first fashion
    - DF: All modules on a major control path are integrated
    - BF: All modules directly subordinate at each level are integrated
  - The main control module is used as a test driver, and stubs are substituted for all components directly subordinate to the main control module
  - Depending on the integration approach selected subordinate stubs are replaced one at a time with actual components
  - Tests are conducted as each component is integrated
  - On completion of each set of tests, another stub is replaced with real component

- **Top-down Integration**

- Advantages

- This approach verifies major control or decision points early in the test process

- Disadvantages

- Stubs need to be created to substitute for modules that have not been built or tested yet; this code is later discarded
    - Because stubs are used to replace lower level modules, no significant data flow can occur until much later in the integration/testing process

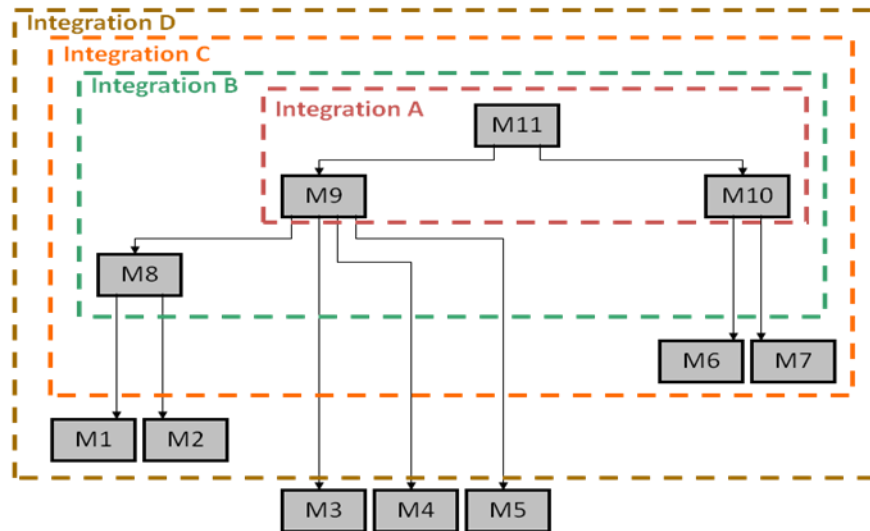

- **Bottom-up Integration**

- Integration and testing starts with the most atomic modules (i.e., components at the lowest levels in the program structure ) in the control hierarchy
  - Begins construction and testing with atomic modules. As components are integrated from the bottom up, processing required for components subordinate to a given level is always available and the need for stubs is eliminated
  - Low-level components are combined into clusters that perform a specific software sub-function
  - A driver is written to coordinate test case input and output
  - The cluster is tested
  - Drivers are removed and clusters are combined moving upward in the program structure
  - As integration moves upward, the need for separate test drivers lessens. If the top two levels of program structure are integrated top down, the number of drivers can be reduced substantially and integration of clusters is greatly simplified

- Bottom-up Integration
  - Advantages
    - This approach verifies low-level data processing early in the testing process
    - Need for stubs is eliminated
  - Disadvantages
    - Driver modules need to be built to test the lower-level modules; this code is later discarded or expanded into a full-featured version
    - Drivers inherently do not contain the complete algorithms that will eventually use the services of the lower-level modules; consequently, testing may be incomplete or more testing may be needed later when the upper level modules are available

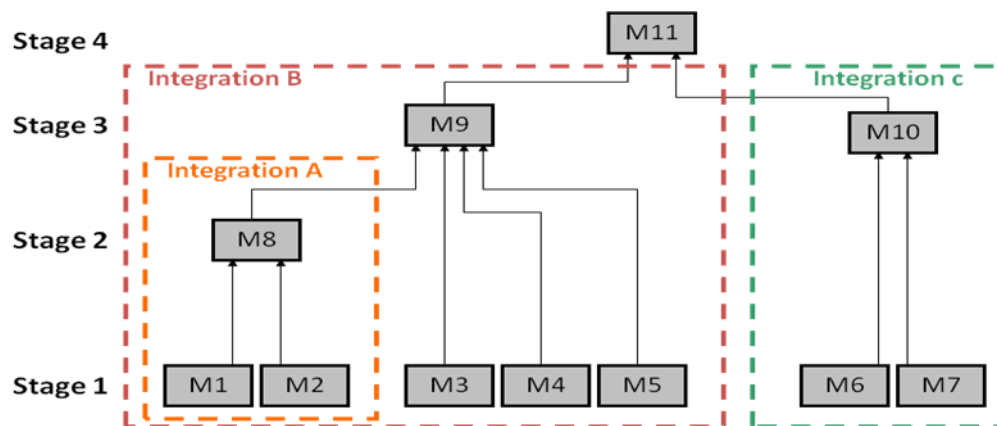

## Use of stubs and drivers for incremental testing

### Top-down testing of module M8

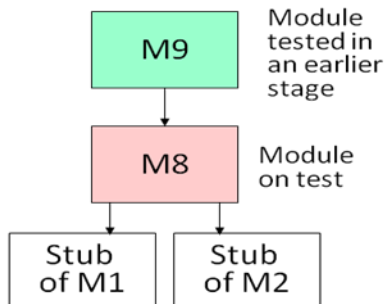

### Bottom-up testing of module M8

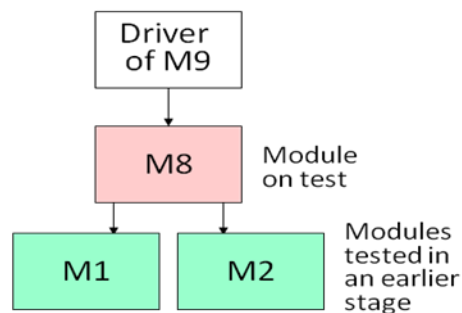

### **Sandwich Integration**

- Consists of a combination of both top-down and bottom-up integration
- Occurs both at the highest level modules and also at the lowest level modules

- Proceeds using functional groups of modules, with each group completed before the next
  - High and low-level modules are grouped based on the control and data processing they provide for a specific program feature
  - Integration within the group progresses in alternating steps between the high and low level modules of the group
  - When integration for a certain functional group is complete, integration and testing moves onto the next group
- Reaps the advantages of both types of integration while minimizing the need for drivers and stubs
- Requires a disciplined approach so that integration doesn't tend towards the "big bang" scenario

### **Smoke Testing**

- Taken from the world of hardware
  - Power is applied and a technician checks for sparks, smoke, or other dramatic signs of fundamental failure
- Designed as a pacing mechanism for time-critical projects
  - Allows the software team to assess its project on a frequent basis
- Includes the following activities
  - The software is compiled and linked into a build
  - A series of breadth tests is designed to expose errors that will keep the build from properly performing its function
- The goal is to uncover "show stopper" errors that have the highest likelihood of throwing the software project behind schedule
  - The build is integrated with other builds and the entire product is smoke tested daily
- Daily testing gives managers and practitioners a realistic assessment of the progress of the integration testing
  - After a smoke test is completed, detailed test scripts are executed
- Benefits of Smoke Testing
  - Integration risk is minimized
    - Daily testing uncovers incompatibilities and show-stoppers early in the testing process, thereby reducing schedule impact
  - The quality of the end-product is improved
    - Smoke testing is likely to uncover both functional errors and architectural and component-level design errors
  - Error diagnosis and correction are simplified
    - Smoke testing will probably uncover errors in the newest components that were integrated
  - Progress is easier to assess
    - As integration testing progresses, more software has been integrated and more has been demonstrated to work
    - Managers get a good indication that progress is being made

## Validation Testing

- Validation testing follows integration testing
  - The distinction between conventional and object-oriented software disappears
  - Focuses on user-visible actions and user-recognizable output from the system
  - Demonstrates conformity with requirements
  -

### 1. Validation-Test Criteria

- Designed to ensure that
  - All functional requirements are satisfied
  - All behavioral characteristics are achieved
  - All performance requirements are attained
  - Documentation is correct
  - Usability and other requirements are met (e.g., transportability, compatibility, error recovery, maintainability)
  - After each validation test
  - The function or performance characteristic conforms to specification and is accepted
  - A deviation from specification is uncovered and a deficiency list is created
  - Deviation or error discovered at this stage in a project can rarely be corrected prior to scheduled delivery
  -

### 2. A configuration review or audit ensures that all elements of the software configuration have been properly developed, cataloged, and have the necessary detail for entering the support phase of the software life cycle (activities)

- It is virtually impossible for a software developer to foresee how the customer will really use a program.
- Instructions for use may be misinterpreted; strange combinations of data may be regularly used; output that seemed clear to the tester may be unintelligible to a user in the field.
- When custom software is built for one customer, a series of acceptance tests are conducted to enable the customer to validate all requirements. Conducted by the end user rather than software engineers, an acceptance test can range from an informal “test drive” to a planned and systematically executed series of tests.
- In fact, acceptance testing can be conducted over a period of weeks or months, thereby uncovering cumulative errors that might degrade the system over time.
- If software is developed as a product to be used by many customers, it is impractical to perform formal acceptance tests with each one. Most software product builders use a process called alpha and beta testing to uncover errors that only the end user seems able to find.



### 3. Alpha and Beta Testing

- Alpha Testing
  - Conducted at the developer's site by end users
  - Software is used in a natural setting with developers watching intently
  - Testing is conducted in a controlled environment
- Beta Testing
  - Conducted at end-user sites
  - Developer is generally not present
  - It serves as a live application of the software in an environment that cannot be controlled by the developer Alpha and Beta Testing
- Beta Testing
  - The end-user records all problems that are encountered and reports these to the developers at regular intervals
- After beta testing is complete, software engineers make software modifications and prepare for release of the software product to the entire customer base.

### System Testing

- System testing is a series of different test whose primary purpose is to fully exercise the computer-based system.
- Each test has a different purpose, all work to verify that system elements have been properly integrated and perform allocated functions.

#### 1. Recovery testing

- Tests for recovery from system faults
- Forces the software to fail in a variety of ways and verifies that recovery is properly performed
- Tests reinitialization, checkpointing mechanisms, data recovery, and restart for correctness
- If recovery is automatic, reinitialization, checkpointing mechanisms, data recovery, and restart are evaluated for correctness
- If recovery requires human intervention, the mean-time-to-repair is evaluated to determine whether it is within acceptable limits

## 2. Security testing

- Verifies that protection mechanisms built into a system will, in fact, protect it from improper access
- During security testing, the tester plays the role of the individual who desires to penetrate the system.
- Anything goes! The tester may attempt to acquire passwords through external clerical means.
- may attack the system with custom software designed to break down any defenses that have been constructed

## 3. Stress testing

- Executes a system in a manner that demands resources in abnormal quantity, frequency, or volume.
- Stress tests are designed to confront programs with abnormal situations. In essence, the tester who performs stress testing asks: “How high can we crank this up before it fails?”
- A variation of stress testing is a technique called sensitivity testing.
  - A very small range of data contained within the bounds of valid data for a program may cause extreme and even erroneous processing or profound performance degradation.
  - Sensitivity testing attempts to uncover data combinations within valid input classes that may cause instability or improper processing.

## 4. Performance Testing

- Performance testing is designed to test the run-time performance of software within the context of an integrated system.
- Performance testing occurs throughout all steps in the testing process. Even at the unit level, the performance of an individual module may be assessed as tests are conducted
- Performance tests are often coupled with stress testing and usually requires both hardware and software instrumentation.
- That is, it is often necessary to measure resource utilization (e.g., processor cycles) in an exacting fashion

## The art of Debugging

Debugging occurs as a consequence of successful testing. When a test case uncovers an error, debugging is an action that results in the removal of the error.

### 1. The debugging process

The debugging process attempts to match symptom with cause, thereby leading to error correction.

The debugging process will usually have one of two outcomes:

- (1) the cause will be found and corrected or
- (2) the cause will not be found. In the latter case, the person performing debugging may suspect a cause, design a test case to help validate that suspicion, and work toward error correction in an iterative fashion.
  - Debugging process begins with the execution of a test case. Results are assessed and a lack of correspondence between expected and actual performance is observed
  - Debugging attempts to match symptom with cause, thereby leading to error correction

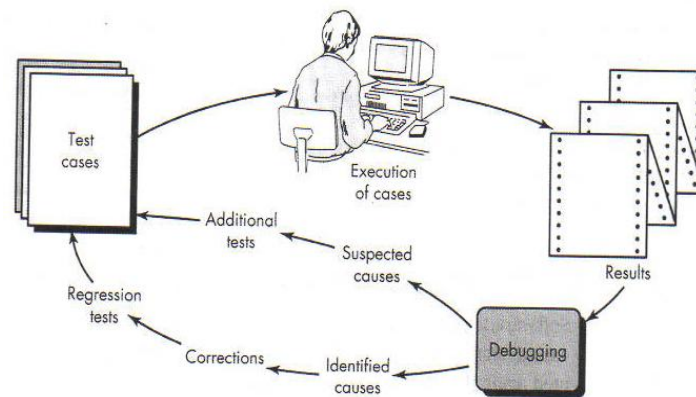

### • Characteristics of bugs

- The symptom and the cause may be geographically remote.
- The symptom may disappear (temporarily) when another error is corrected
- The symptom may actually be caused by non-errors
- The symptom may be caused by human error that is not easily traced
- The symptom may be a result of timing problems, rather than processing problems
- It may be difficult to accurately reproduce input conditions
- The symptom may be intermittent.
- The symptom may be due to causes that are distributed across a number of tasks running on different processors

### 2. Psychological Considerations

- Unfortunately, there appears to be some evidence that debugging prowess is an innate human trait. Some people are good at it and others aren't.

- Although experimental evidence on debugging is open to many interpretations, large variances in debugging ability have been reported for programmers with the same education and experience.

- 

### 3. Debugging Strategies

- Objective of debugging is to find and correct the cause of a software error or defect.
- Bugs are found by a combination of systematic evaluation, intuition, and luck.
- Debugging methods and tools are not a substitute for careful evaluation based on a complete design model and clear source code
- There are three main debugging strategies
  1. Brute force
  2. Backtracking
  3. Cause elimination

- **Brute Force**

- Most commonly used and least efficient method for isolating the cause of a software error
- Used when all else fails
- Involves the use of memory dumps, run-time traces, and output statements
- Leads many times to wasted effort and time

- **Backtracking**

- Can be used successfully in small programs
- The method starts at the location where a symptom has been uncovered
- The source code is then traced backward (manually) until the location of the cause is found
- In large programs, the number of potential backward paths may become unmanageably large

- **Cause Elimination**

- Involves the use of induction or deduction and introduces the concept of binary partitioning
  - Induction (specific to general): Prove that a specific starting value is true; then prove the general case is true
  - Deduction (general to specific): Show that a specific conclusion follows from a set of general premises
- Data related to the error occurrence are organized to isolate potential causes
- A cause hypothesis is devised, and the aforementioned data are used to prove or disprove the hypothesis
- Alternatively, a list of all possible causes is developed, and tests are conducted to eliminate each cause
- If initial tests indicate that a particular cause hypothesis shows promise, data are refined in an attempt to isolate the bug

#### 4. Correcting the Error

- Once a bug has been found, it must be corrected.
- But the correction of a bug can introduce other errors and therefore do more harm than good.
- Van Vleck suggests three simple questions that you should ask before making the “correction” that removes the cause of a bug.
- Three Questions to ask Before Correcting the Error
  - Is the cause of the bug reproduced in another part of the program?
    - Similar errors may be occurring in other parts of the program
  - What next bug might be introduced by the fix that I’m about to make?
    - The source code (and even the design) should be studied to assess the coupling of logic and data structures related to the fix
  - What could we have done to prevent this bug in the first place?
    - This is the first step toward software quality assurance
    - By correcting the process as well as the product, the bug will be removed from the current program and may be eliminated from all future programs

#### Coding Practices:

- Best coding practices are a set of informal rules that the software development community has learned over time which can help improve the quality of software
- Many computer programs remain in use for far longer than the original authors ever envisaged (sometimes 40 years or more) so any rules need to facilitate both initial development and subsequent maintenance and enhancement by people other than the original authors.
- In Ninety-ninety rule, Tim Cargill is credited with this explanation as to why programming projects often run late: "The first 90% of the code accounts for the first 90% of the development time. The remaining 10% of the code accounts for the other 90% of the development time." Any guidance which can redress this lack of foresight is worth considering.
- The size of a project or program has a significant effect on error rates, programmer productivity, and the amount of management needed
  - a) Maintainability      b) Dependability      c) Efficiency      d) Usability.

#### Refactoring:

- Refactoring is usually motivated by noticing a code smell.
- For example the method at hand may be very long, or it may be a near duplicate of another nearby method.
- Once recognized, such problems can be addressed by *refactoring* the source code, or transforming it into a new form that behaves the same as before but that no longer "smells".

**There are two general categories of benefits to the activity of refactoring.**

**Maintainability.** It is easier to fix bugs because the source code is easy to read and the intent of its author is easy to grasp. This might be achieved by reducing large monolithic routines into a set of

individually concise, well-named, single-purpose methods. It might be achieved by moving a method to a more appropriate class, or by removing misleading comments.

**Extensibility.** It is easier to extend the capabilities of the application if it uses recognizable design patterns, and it provides some flexibility where none before may have existed.

- Before applying a refactoring to a section of code, a solid set of automatic unit tests is needed. The tests are used to demonstrate that the behavior of the module is correct before the refactoring.
- The tests can never prove that there are no bugs, but the important point is that this process can be cost-effective: good unit tests can catch enough errors to make them worthwhile and to make refactoring safe enough.

**UNIT – V: Project Management: Estimation: FP based, LOC based, make/buy decision; COCOMO II: Planning, project plan, planning process, RFP risk management, identification, projection; RMMM: Scheduling and tracking, relationship between people and effort, task set and network, scheduling; EVA: Process and project metrics.**

### **Estimation:**

Software cost and effort estimation will never be an exact science. Too many variables—human, technical, environmental, political—can affect the ultimate cost of software and effort applied to develop it.

### **To achieve reliable cost and effort estimates, a number of options arise:**

- Delay estimation until late in the project (obviously, we can achieve 100 percent accurate estimates after the project is complete!).
- Base estimates on similar projects that have already been completed.
- Use relatively simple decomposition techniques to generate project cost and effort estimates.
- Use one or more empirical models for software cost and effort estimation.

Unfortunately, the first option, however attractive, is not practical. Cost estimates must be provided up-front. However, recognize that the longer you wait, the more you know, and the more you know, the less likely you are to make serious errors in your estimates.

The second option can work reasonably well, if the current project is quite similar to past efforts and other project influences (e.g., the customer, business conditions, the software engineering environment, deadlines) are roughly equivalent. Unfortunately, past experience has not always been a good indicator of future results.

### **Function Point based Estimation:**

- A **Function Point** (FP) is a unit of measurement to express the amount of business functionality, an information system (as a product) provides to a user. FPs measure software size. They are widely accepted as an industry standard for functional sizing
- Function point analysis is a method of quantifying the size and complexity of a software system in terms of the functions that the system delivers to the user
- It is independent of the computer language, development methodology, technology or capability of the project team used to develop the application
- Function point analysis is designed to measure business applications (not scientific applications)
- Scientific applications generally deal with complex algorithms that the function point method is not designed to handle
- Function points are independent of the language, tools, or methodologies used for implementation (ex. Do not take into consideration programming languages, DBMS, or processing hardware)
- Function points can be estimated early in analysis and design

### **Uses of Function Point:**

- Measure productivity (ex. Number of function points achieved per work hour expended)
- Estimate development and support (cost benefit analysis, staffing estimation)

- Monitor outsourcing agreements (Ensure that the outsourcing entity delivers the level of support and productivity gains that they promise)
- Drive IS related business decisions (Allow decisions regarding the retaining, retiring and redesign of applications to be made)
- Normalize other measures (Other measures, such as defects, frequently require the size in function points)

### LOC based estimation:

- Source lines of code (SLOC), also known as lines of code (LOC), is a software metric used to measure the size of a computer program by counting the number of lines in the text of the program's source code.
- SLOC is typically used to predict the amount of effort that will be required to develop a program, as well as to estimate programming productivity or maintainability once the software is produced.
- Lines used for commenting the code and header file are ignored.

Two major types of LOC:

#### 1. Physical LOC

- ✓ Physical LOC is the count of lines in the text of the program's source code including comment lines.
- ✓ Blank lines are also included unless the lines of code in a section consists of more than 25% blank lines.

#### 2. Logical LOC

- ✓ Logical LOC attempts to measure the number of executable statements, but their specific definitions are tied to specific computer languages.
- ✓ Ex: Logical LOC measure for C-like programming languages is the number of statement-terminating semicolons(;

### The problems of lines of code (LOC):

- Different languages lead to different lengths of code
- It is not clear how to count lines of code
- A report, screen, or GUI generator can generate thousands of lines of code in minutes
- Depending on the application, the complexity of code is different.

### make/buy decision:

- In many software application areas, it is often more cost effective to acquire rather than develop computer software. Software engineering managers are faced with a make/ buy decision that can be further complicated by a number of acquisition options.

- (1) Software may be purchased (or licensed) off-the-shelf
- (2) “full-experience” or “partial-experience” software components may be acquired and then modified and integrated to meet specific needs.
- (3) Software may be custom built by an outside contractor to meet the purchaser’s specifications.



In the final analysis the make/buy decision is made based on the following conditions:

- (1) Will the delivery date of the software product be sooner than that for internally developed software?
- (2) Will the cost of acquisition plus the cost of customization be less than the cost of developing the software internally?
- (3) Will the cost of outside support (e.g., a maintenance contract) be less than the cost of internal support?

Creating a Decision Tree:

- The steps just described can be augmented using statistical techniques such as decision tree analysis. For example, considered the figure below it depicts a decision tree for a software based system X. In this case, the software engineering organization can
  - (1) build system X from scratch
  - (2) reuse existing partial-experience components to construct the system
  - (3) buy an available software product and modify it to meet local needs, or
  - (4) contract the software development to an outside vendor.

If the system is to be built from scratch, there is a 70 percent probability that the job will be difficult. The expected value for cost, computed along any branch of the decision tree, is:

$$\text{Expected cost} = \sum (\text{path probability})_i \times (\text{estimated path cost})_i$$

Where i is the decision tree path. For the build path.

- It is important to note, however, that many criteria —not just cost—must be considered during the decision-making process. Availability, experience of the developer/ vendor/contractor, conformance to requirements, local “politics,” and the likelihood of change are but a few of the criteria that may affect the ultimate decision to build, reuse, buy, or contract.

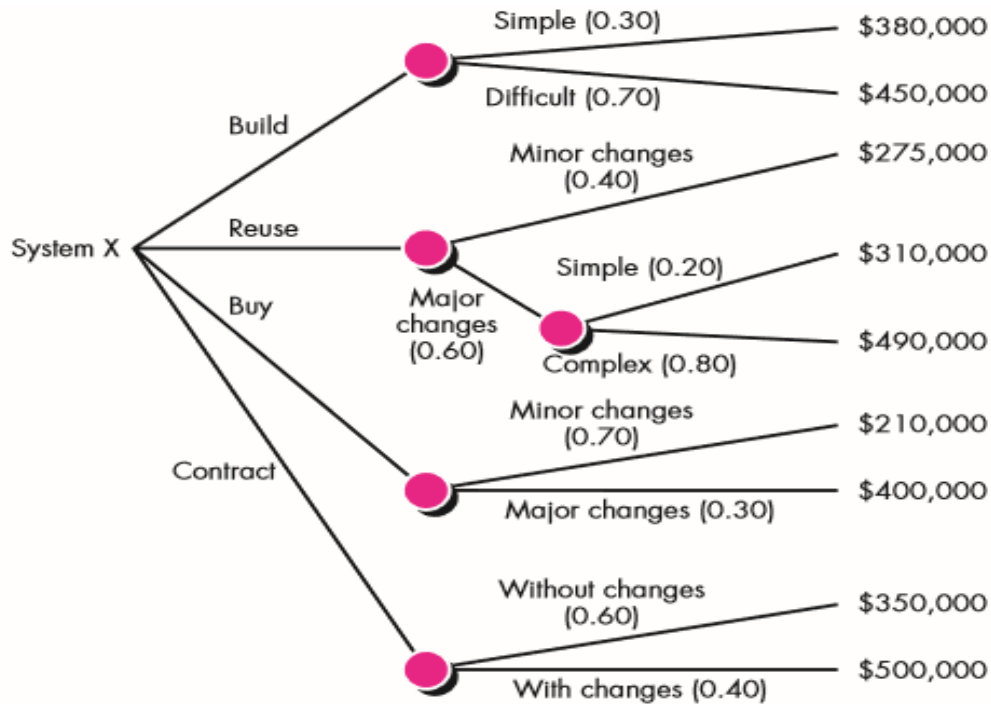

### Outsourcing:

- Sooner or later, every company that develops computer software asks a fundamental question: “Is there a way that we can get the software and systems we need at a lower price?”
- The answer to this question is not a simple one, and the emotional discussions that occur in response to the question always lead to a single word: outsourcing. Regardless of the breadth of focus, the outsourcing decision is often a financial one.
- Outsourcing is extremely simple. Software engineering activities are contracted to a third party who does the work at lower cost and, hopefully, higher quality.
- The decision to outsource can be either strategic or tactical.
- At the strategic level, business managers consider whether a significant portion of all software work can be contracted to others.
- At the tactical level, a project manager determines whether part or all of a project can be best accomplished by subcontracting the software work.
- On the positive side, cost savings can usually be achieved by reducing the number of software people and the facilities (e.g., computers, infrastructure) that support them.
- On the negative side, a company loses some control over the software that it needs.

## COCOMO – II MODEL

Barry Boehm [Boe81] introduced a hierarchy of software estimation models bearing the name COCOMO, for Constructive Cost Model. The original COCOMO model became one of the most widely used and discussed software cost estimation models in the industry. It has evolved into a more comprehensive estimation model, called COCOMOII.

COCOMOII is actually a hierarchy of estimation models that address the following areas:

**Application composition model.** Used during the early stages of software engineering, when prototyping of user interfaces, consideration of software and system interaction, assessment of performance, and evaluation of technology maturity are paramount.

**Early design stage model.** Used once requirements have been stabilized and basic software architecture has been established.

**Post-architecture-stage model.** Used during the construction of the software.

- The COCOMO II models require sizing information.
- Three different sizing options are available as part of the model hierarchy: object points, function points, and lines of source code.

The COCOMO II application composition model uses object points:

- The object point is an indirect software measure that is computed using counts of the number of
  - (1) screens (at the user interface),
  - (2) reports
  - (3) components likely to be required to build the application.
- Each object instance (e.g., a screen or report) is classified into one of three complexity levels (i.e., simple, medium, or difficult).
- Once complexity is determined, the number of screens, reports, and components are weighted according to the table given below

Object type	Complexity weight		
	Simple	Medium	Difficult
Screen	1	2	3
Report	2	5	8
3GL component			10

- When component-based development or general software reuse is to be applied, the percent of reuse (%reuse) is estimated and the object point count is adjusted:

$$\text{NOP} = (\text{object points}) \times [(100 - \%reuse)/100]$$

where NOP is defined as new object points.

- To derive an estimate of effort based on the computed NOP value, a “productivity rate” must be derived.

$$\text{PROD} = \frac{\text{NOP}}{\text{person-month}}$$

- Once the productivity rate has been determined, an estimate of project effort is computed using,

$$\text{Estimated effort} = \frac{\text{NOP}}{\text{PROD}}$$

<b>Developer's experience/capability</b>	Very low	Low	Nominal	High	Very high
<b>Environment maturity/capability</b>	Very low	Low	Nominal	High	Very high
<b>PROD</b>	4	7	13	25	50

### The Project Planning Process:

- The Project Planning Phase is the second phase in the *project life cycle*. It involves creating of a set of plans to help guide your team through the execution and closure phases of the project.
- The plans created during this phase will help you to manage time, cost, quality, change, risk and issues. They will also help you manage staff and external suppliers, to ensure that you deliver the project on time and within budget.
- The objective of software project planning is to provide a framework that enables the manager to make reasonable estimates of resources, cost, and schedule.
- In addition, estimates should attempt to define best-case and worst-case scenarios so that project outcomes can be bounded.
- Although there is an inherent degree of uncertainty, the software team embarks on a plan that has been established as a consequence of these tasks.
- Therefore, the plan must be adapted and updated as the project proceeds.
- The Project Planning Phase is often the most challenging phase for a Project Manager, as you need to make an educated guess of the staff, resources and equipment needed to complete your project. You may also need to plan your communications and procurement activities, as well as contract any 3rd party suppliers.

## **RFP RISK MANAGEMENT:**

### **A Hazard is**

Any real or potential condition that can cause injury, illness, or death to personnel; damage to or loss of a system, equipment or property; or damage to the environment. Simpler.... A threat of harm. A hazard can lead to one or several consequences.

A Risk is

- The expectation of a loss or damage (consequence)
- The combined severity and probability of a loss
- The long term rate of loss

A potential problem (leading to a loss) that may - or may not occur in the future.

- Risk Management is A set of practices and support tools to identify, analyze, and treat risks explicitly.
- Treating a risk means understanding it better, avoiding or reducing it (risk mitigation), or preparing for the risk to materialize.
- Risk management tries to reduce the probability of a risk to occur and the impact (loss) caused by risks.

### **Reactive versus Proactive Risk Strategies**

- Software risks
- Reactive versus Proactive Risk Strategies
- The majority of software teams rely solely on reactive risk strategies. At best, a reactive strategy monitors the project for likely risks. Resources are set aside to deal with them, should they become actual problems.
- The software team does nothing about risks until something goes wrong. Then, the team flies into action in an attempt to correct the problem rapidly. This is often called a fire-fighting mode.
- A considerably more intelligent strategy for risk management is to be proactive.
- A proactive strategy begins long before technical work is initiated. Potential risks are identified, their probability and impact are assessed, and they are ranked by importance. Then,
- The software team establishes a plan for managing risk. The primary objective is to avoid risk, but because not all risks can be avoided, the team works to develop a contingency plan that will enable it to respond in a controlled and effective manner.

## **Risk always involves two characteristics:**

- Risk always involves two characteristics: uncertainty—the risk may or may not happen; that is, there are no 100 percent probable risks—and loss—if the risk becomes a reality, unwanted consequences or losses will occur.
- When risks are analyzed, it is important to quantify the level of uncertainty and the degree of loss associated with each risk.
- **Different categories of risks are follows:**

### *1. Project risks*

- ❖ Threaten the project plan. That is, if project risks become real, it is likely that the project schedule will slip and that costs will increase.
- ❖ Project risks identify potential budgetary, schedule, personnel (staffing and organization), resource, stakeholder, and requirements problems and their impact on a software project.

### *2. Technical risks*

- ❖ Threaten the quality and timeliness of the software to be produced.
- ❖ If a technical risk becomes a reality, implementation may become difficult or impossible. Technical risks identify potential design, implementation, interface, verification, and maintenance problems.
- ❖ In addition, specification ambiguity, technical uncertainty, technical obsolescence, and “leading-edge” technology are also risk factors. Technical risks occur because the problem is harder to solve than you thought it would be.

### *3. Business risks*

- ❖ Business risks threaten the viability of the software to be built and often jeopardize the project or the product.
- ❖ Candidates for the top five business risks are
  1. building an excellent product or system that no one really wants (market risk)
  2. building a product that no longer fits into the overall business strategy for the company (strategic risk)
  3. building a product that the sales force doesn't understand how to sell (sales risk)
  4. losing the support of senior management due to a change in focus or a change in people (management risk)
  5. losing budgetary or personnel commitment (budget risks).

### **Another general categorization of risks has been proposed by Charette.**

4. *Known risks* are those that can be uncovered after careful evaluation of the project plan, the business and technical environment in which the project is being developed, and other reliable information sources (e.g., unrealistic delivery date, lack of documented requirements or software scope, poor development environment).
5. *Predictable risks* are extrapolated from past project experience (e.g., staff turnover, poor communication with the customer, dilution of staff effort as ongoing maintenance requests are serviced).
6. *Unpredictable risks* are the joker in the deck. They can and do occur, but they are extremely difficult to identify in advance.

### **RISK IDENTIFICATION**

- Risk identification is a systematic attempt to specify threats to the project plan (estimates, schedule, resource loading, etc.).
- By identifying known and predictable risks, the project manager takes a first step toward avoiding them when possible and controlling them when necessary.
- There are two distinct types of risks: generic risks and product-specific risks.
- Generic risks are a potential threat to every software project.
- Product-specific risks can be identified only by those with a clear understanding of the technology, the people, and the environment that is specific to the software that is to be built.
- To identify product-specific risks, the project plan and the software statement of scope are examined, and an answer to the following question is developed: “What special characteristics of this product may threaten our project plan?”
- One method for identifying risks is to create a risk item checklist.
- The checklist can be used for risk identification and focuses on some subset of known and predictable risks in the following generic subcategories:
  - Product size—risks associated with the overall size of the software to be built or modified.
  - Business impact—risks associated with constraints imposed by management or the marketplace.
  - Stakeholder characteristics—risks associated with the sophistication of the stakeholders and the developer’s ability to communicate with stakeholders in a timely manner.
  - Process definition—risks associated with the degree to which the software process has been defined and is followed by the development organization.
  - Development environment—risks associated with the availability and quality of the tools to be used to build the product.

- Technology to be built—risks associated with the complexity of the system to be built and the “newness” of the technology that is packaged by the system.
- Staff size and experience—risks associated with the overall technical and project experience of the software engineers who will do the work.

### **Assessing Overall Project Risk**

The following questions have been derived from risk data obtained by surveying experienced software project managers in different parts of the world.

1. Have top software and customer managers formally committed to support the project?
  2. Are end users enthusiastically committed to the project and the system/ product to be built?
  3. Are requirements fully understood by the software engineering team and its customers?
  4. Have customers been involved fully in the definition of requirements?
  5. Do end users have realistic expectations?
  6. Is the project scope stable?
  7. Does the software engineering team have the right mix of skills?
  8. Are project requirements stable?
  9. Does the project team have experience with the technology to be implemented?
  10. Is the number of people on the project team adequate to do the job?
  11. Do all customer/user constituencies agree on the importance of the project and on the requirements for the system/product to be built
- The project manager identify the risk drivers that affect software risk components— performance, cost, support, and schedule.

### **The risk components are defined in the following manner:**

- Performance risk—the degree of uncertainty that the product will meet its requirements and be fit for its intended use.
- Cost risk—the degree of uncertainty that the project budget will be maintained.
- Support risk—the degree of uncertainty that the resultant software will be easy to correct, adapt, and enhance.
- Schedule risk—the degree of uncertainty that the project schedule will be maintained and that the product will be delivered on time.
- The impact of each risk driver on the risk component is divided into one of four impact categories—negligible, marginal, critical, or catastrophic.



## **Risk Projection**

- Risk projection, also called risk estimation, attempts to rate each risk in two ways.
  1. The likelihood or probability that the risk is real and
  2. The consequences of the problems associated with the risk, should it occur

### **Managers and technical staff to perform four risk projection steps:**

1. Establish a scale that reflects the perceived likelihood of a risk.
2. Delineate the consequences of the risk.
3. Estimate the impact of the risk on the project and the product.
4. Assess the overall accuracy of the risk projection so that there will be no misunderstandings.

The intent of these steps is to consider risks in a manner that leads to prioritization. No software team has the resources to address every possible risk with the same degree of rigor. By prioritizing risks, you can allocate resources where they will have the most impact.

## **Developing a Risk Table**

- A risk table provides you with a simple technique for risk projection. A sample risk table is illustrated in Figure.
- List all the risks (no matter how remote) in the first column of the table.
- Each risk is categorized in the second column (e.g., PS implies a project size risk, BU implies a business risk).
- The probability of occurrence of each risk is entered in the next column of the table. The probability value for each risk can be estimated by team members individually.
- Next, the impact of each risk is assessed. Each risk component is assessed, and an impact category is determined.
- The categories for each of the four risk components—performance, support, cost, and schedule—are averaged to determine an overall impact value.
- Once the first four columns of the risk table have been completed, the table is sorted by probability and by impact.
- High-probability, high-impact risks percolate to the top of the table, and low-probability risks drop to the bottom.

## **Sample Risk table prior to sorting**

Risks	Category	Probability	Impact	RMMM
Size estimate may be significantly low	PS	60%	2	
Larger number of users than planned	PS	30%	3	
Less reuse than planned	PS	70%	2	
End-users resist system	BU	40%	3	
Delivery deadline will be tightened	BU	50%	2	
Funding will be lost	CU	40%	1	
Customer will change requirements	PS	80%	2	
Technology will not meet expectations	TE	30%	1	
Lack of training on tools	DE	80%	3	
Staff inexperienced	ST	30%	2	
Staff turnover will be high	ST	60%	2	
Σ				
Σ				
Σ				

Impact values:  
 1—catastrophic  
 2—critical  
 3—marginal  
 4—negligible

## 2. Assessing Risk Impact

- Three factors affect the consequences that are likely if a risk does occur: its nature, its scope, and its timing.
- The nature of the risk indicates the problems that are likely if it occurs. For example, a poorly defined external interface to customer hardware (a technical risk) will preclude early design and testing and will likely lead to system integration problems late in a project.
- The scope of a risk combines the severity (just how serious is it?) with its overall distribution (how much of the project will be affected or how many stakeholders are harmed?).
- The timing of a risk considers when and for how long the impact will be felt. In most cases, you want the “bad news” to occur as soon as possible, but in some cases, the longer the delay, the better.
- The overall risk exposure RE is determined using the following relationship

$$RE = P * C$$

where P is the probability of occurrence for a risk, and C is the cost to the project should the risk occur.

Risk Mitigation, Monitoring, and Management:

- An effective strategy for dealing with risk must consider three issues  
 (Note: these are not mutually exclusive)

- Risk mitigation
- Risk monitoring
- Risk management and contingency planning
- Risk mitigation - is the primary strategy and is achieved through a plan
  - Example: Risk of high staff turnover
- Meet with current staff to determine causes for turnover (e.g., poor working conditions, low pay, competitive job market)
- Mitigate those causes that are under our control before the project starts
- Once the project commences, assume turnover will occur and develop techniques to ensure continuity when people leave
- Organize project teams so that information about each development activity is widely dispersed
- Define documentation standards and establish mechanisms to ensure that documents are developed in a timely manner
- Conduct peer reviews of all work (so that more than one person is "up to speed")
- Assign a backup staff member for every critical technologist.
- During risk monitoring, the project manager monitors factors that may provide an indication of whether a risk is becoming more or less likely
- Risk management and contingency planning assume that mitigation efforts have failed and that the risk has become a reality
- RMMM steps incur additional project cost
  - Large projects may have identified 30 – 40 risks
- Risk is not limited to the software project itself
  - Risks can occur after the software has been delivered to the user
- Software safety and hazard analysis
  - These are software quality assurance activities that focus on the identification and assessment of potential hazards that may affect software negatively and cause an entire system to fail
  - If hazards can be identified early in the software process, software design features can be specified that will either eliminate or control potential hazards.
  - It is important to note that risk mitigation, monitoring, and management (RMMM) steps

incur additional project cost

- The RMMM plan may be a part of the software development plan or may be a separate document
- Once RMMM has been documented and the project has begun, the risk mitigation, and monitoring steps begin
  - Risk mitigation is a problem avoidance activity
  - Risk monitoring is a project tracking activity
- Risk monitoring has three objectives
  - To assess whether predicted risks do, in fact, occur
  - To ensure that risk aversion steps defined for the risk are being properly applied
  - To collect information that can be used for future risk analysis
- The findings from risk monitoring may allow the project manager to ascertain what risks caused which problems throughout the project

#### SCHEDULING AND TRACKING:

- ✓ You've selected an appropriate process model.
- ✓ You've identified the software engineering tasks that have to be performed.
- ✓ You estimated the amount of work and the number of people, you know the deadline, you've even considered the risks.
- ✓ Now it's time to connect the dots. That is, you have to create a network of software engineering tasks that will enable you to get the job done on time.
- ✓ Once the network is created, you have to assign responsibility for each task, make sure it gets done, and adapt the network as risks become reality.
- Why it's Important?
  - ✓ In order to build a complex system, many software engineering tasks occur in parallel.
  - ✓ The result of work performed during one task may have a profound effect on work to be conducted in another task.
  - ✓ These interdependencies are very difficult to understand without a schedule.
  - ✓ It's also virtually impossible to assess progress on a moderate or large software project without a detailed schedule

- What are the steps?
  - ✓ The software engineering tasks dictated by the software process model are refined for the functionality to be built.
  - ✓ Effort and duration are allocated to each task and a task network (also called an “activity network”) is created in a manner that enables the software team to meet the delivery deadline established.

#### Basic Concept of Project Scheduling

- ✓ An unrealistic deadline established by someone outside the software development group and forced on managers and practitioner's within the group.
  - ✓ Changing customer requirements that are not reflected in schedule changes.
  - ✓ An honest underestimate of the amount of effort and/or the number of resources that will be required to do the job.
  - ✓ Predictable and/or unpredictable risks that were not considered when the project commenced.
  - ✓ Technical difficulties that could not have been foreseen in advance.
- Why should we do when the management demands that we make a dead line I impossible?
    - ✓ Perform a detailed estimate using historical data from past projects.
    - ✓ Determine the estimated effort and duration for the project.
    - ✓ Using an incremental process model, develop a software engineering strategy that will deliver critical functionality by the imposed deadline, but delay other functionality until later. Document the plan.
    - ✓ Meet with the customer and (using the detailed estimate), explain why the imposed deadline is unrealistic.

#### Project Scheduling

- Basic Principles
- The Relationship Between People and Effort
- Effort Distribution
- Software project scheduling is an action that distributes estimated effort across the planned project duration by allocating the effort to specific software engineering tasks.
- During early stages of project planning, a macroscopic schedule is developed.
- As the project gets under way, each entry on the macroscopic schedule is refined into a detailed

schedule.

### Basic Principles of Project Scheduling.

1. **Compartmentalization:** The project must be compartmentalized into a number of manageable activities and tasks. To accomplish compartmentalization, both the product and the process are refined.
2. **Interdependency:** The interdependency of each compartmentalized activity or task must be determined. Some tasks must occur in sequence, while others can occur in parallel. Other activities can occur independently.
3. **Time allocation:** Each task to be scheduled must be allocated some number of work units (e.g., person- days of effort). In addition, each task must be assigned a start date and a completion date. Whether work will be conducted on a full-time or part-time basis.
4. **Effort validation:** Every project has a defined number of people on the software team. The project manager must ensure that no more than the allocated number of people have been scheduled at any given time.
5. **Defined responsibilities.** Every task that is scheduled should be assigned to a specific team member.
6. **Defined outcomes:** Every task that is scheduled should have a defined outcome. For software projects, the outcome is normally a work product (e.g., the design of a component) or a part of a work product. Work products are often combined in deliverables.
7. **Defined milestones:** Every task or group of tasks should be associated with a project milestone. A milestone is accomplished when one or more work products has been reviewed for quality and has been approved.

Each of these principles is applied as the project schedule evolves.

### The Relationship between People and Effort:

- In small software development project a single person can analyze requirements, perform design, generate code, and conduct tests. As the size of a project increases, more people must become involved.
- There is a common myth that is still believed by many managers who are responsible for software development projects: “If we fall behind schedule, we can always add more programmers and catch up later in the project.”
- Unfortunately, adding people late in a project often has a disruptive effect on the project, causing schedules to slip even further. The people who are added must learn the system, and the people who teach them are the same people who were doing the work.
- While teaching, no work is done, and the project falls further behind. In addition to the time it takes to learn the system, more people.
- Although communication is absolutely essential to successful software development, every new communication path requires additional effort and therefore additional time.

## Effort distribution

- A recommended distribution of effort across the software process is often referred to as the 40–20–40 rule.
- Forty percent of all effort is allocated to frontend analysis and design. A similar percentage is applied to back-end testing. You can correctly infer that coding (20 percent of effort) is deemphasized.
- Work expended on project planning rarely accounts for more than 2 to 3 percent of effort, unless the plan commits an organization to large expenditures with high risk.
- Customer communication and requirements analysis may comprise 10 to 25 percent of project effort.
- Effort expended on analysis or prototyping should increase in direct proportion with project size and complexity.
- A range of 20 to 25 percent of effort is normally applied to software design. Time expended for design review and subsequent iteration must also be considered.
- Because of the effort applied to software design, code should follow with relatively little difficulty.
- A range of 15 to 20 percent of overall effort can be achieved. Testing and subsequent debugging can account for 30 to 40 percent of software development effort.
- The criticality of the software often dictates the amount of testing that is required. If software is human rated (i.e., software failure can result in loss of life), even higher percentages are typical.

## TASK SET AND NETWORK:

- A task set is a collection of software engineering work tasks, milestones, work products, and quality assurance filters that must be accomplished to complete a particular project.
  - The task set must provide enough discipline to achieve high software quality. But, at the same time, it must not burden the project team with unnecessary work.
  - Most software organizations encounter the following projects:
    1. Concept development projects that are initiated to explore some new business concept or application of some new technology.
    2. New application development projects that are undertaken as a consequence of a specific customer request.
    3. Application enhancement projects that occur when existing software undergoes major modifications to function, performance, or interfaces that are observable by the end user.
    4. Application maintenance projects that correct, adapt, or extend existing software in ways that may not be immediately obvious to the end user.
    5. Reengineering projects that are undertaken with the intent of rebuilding an existing (legacy) system in whole or in part.
1. A Task Set Example
    - Concept development projects are initiated when the potential for some new technology must be explored. There is no certainty that the technology will be applicable, but a customer (e.g., marketing) believes that potential benefit exists.

## 2. Refinement of Software Engineering Actions

- The software engineering actions are used to define a macroscopic schedule for a project.
- The macroscopic schedule must be refined to create a detailed project schedule.
- Refinement begins by taking each action and decomposing it into a set of tasks (with related work products and milestones).
- A task network, also called an activity network, is a graphic representation of the task flow for a project.
- It is sometimes used as the mechanism through which task sequence and dependencies are input to an automated project scheduling tool.
- In its simplest form (used when creating a macroscopic schedule), the task network depicts major software engineering actions. Figure below shows a schematic task network for a concept development project.
- It is important to note that the task network shown in Figure 27.2 is macroscopic. In a detailed task network (a precursor to a detailed schedule), each action shown in the figure would be expanded.

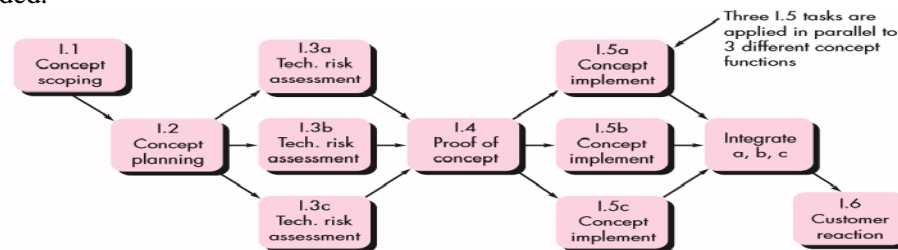

### SCHEDULING:

- Scheduling of a software project does not differ greatly from scheduling of any multitask engineering effort. Therefore, generalized project scheduling tools and techniques can be applied with little modification for software projects.
- Program evaluation and review technique (PERT) and the critical path method (CPM) are two project scheduling methods that can be applied to software development.

#### 1. Time-Line Charts:

- When creating a software project schedule, begin with a set of tasks.
- If automated tools are used, the work breakdown is input as a task network or task outline. Effort, duration, and start date are then input for each task. In addition, tasks may be assigned to specific individuals.
- As a consequence of this input, a time-line chart, also called a Gantt chart, is generated.
- A time-line chart can be developed for the entire project. Alternatively, separate charts can be developed for each project function or for each individual working on the project.
- All project tasks (for concept scoping) are listed in the left hand column. The horizontal bars indicate the duration of each task. When multiple bars occur at the same time on the calendar, task concurrency is implied. The diamonds indicate milestones.
- Once the information necessary for the generation of a time-line chart has been input, the majority of software project scheduling tools produce project tables. —a tabular listing of all



project tasks, their planned and actual start and end dates, and a variety of related information. Used in conjunction with the time-line chart, project tables enable you to track progress.

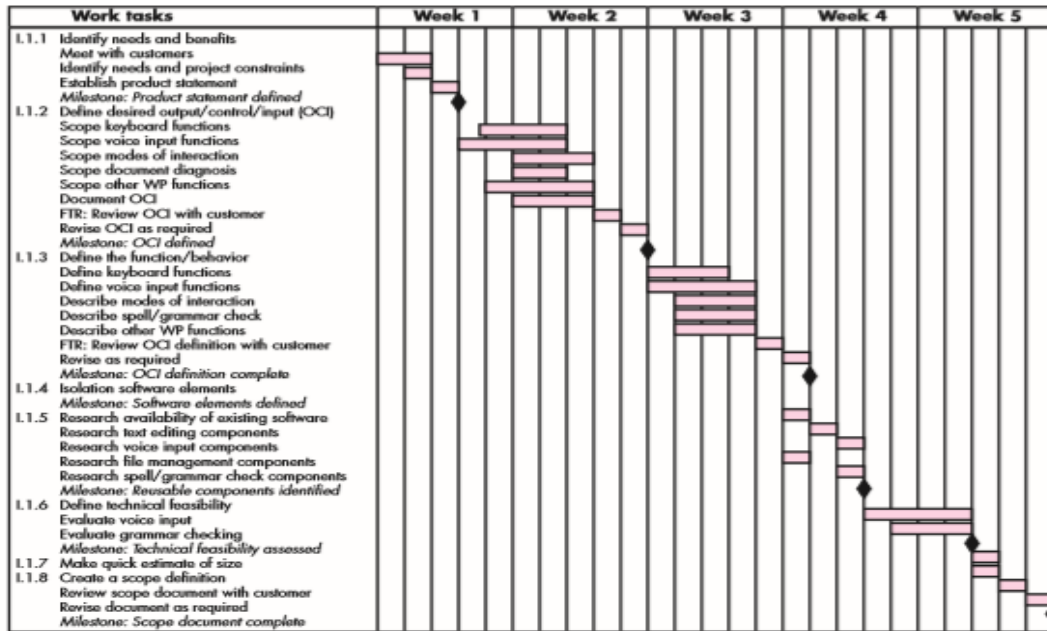

## 2. Tracking the Schedule

- If it has been properly developed, the project schedule becomes a road map that defines the tasks and milestones to be tracked and controlled as the project proceeds.
- Tracking can be accomplished in a number of different ways:
- Conducting periodic project status meetings in which each team member reports progress and problems.
- Evaluating the results of all reviews conducted throughout the software engineering process.
- Determining whether formal project milestones have been accomplished by the scheduled date.
- Comparing the actual start date to the planned start date for each project task listed in the resource table.
- Meeting informally with practitioners to obtain their subjective assessment of progress to date and problems on the horizon.
- Using earned value analysis to assess progress quantitatively.

In reality, all of these tracking techniques are used by experienced project managers.

### 3. Tracking Progress for an OO Project

Technical milestone: OO analysis complete

- All hierarchy classes defined and reviewed
- Class attributes and operations are defined and reviewed
- Class relationships defined and reviewed
- Behavioral model defined and reviewed
- Reusable classes identified

Technical milestone: OO design complete

- Subsystems defined and reviewed
- Classes allocated to subsystems and reviewed
- Task allocation has been established and reviewed
- Responsibilities and collaborations have been identified
- Attributes and operations have been designed and reviewed
- Communication model has been created and reviewed

Technical milestone: OO programming complete

- Each new design model class has been implemented
- Classes extracted from the reuse library have been implemented
- Prototype or increment has been built

Technical milestone: OO testing

- The correctness and completeness of the OOA and OOD models has been reviewed
- Class-responsibility-collaboration network has been developed and reviewed
- Test cases are designed and class-level tests have been conducted for each class
- Test cases are designed, cluster testing is completed, and classes have been integrated
- System level tests are complete

### Scheduling for WebApp Projects

- WebApp project scheduling distributes estimated effort across the planned time line (duration) for building each WebApp increment.
- This is accomplished by allocating the effort to specific tasks.
- The overall WebApp schedule evolves over time.

- During the first iteration, a macroscopic schedule is developed.
- This type of schedule identifies all WebApp increments and projects the dates on which each will be deployed.
- As the development of an increment gets under way, the entry for the increment on the macroscopic schedule is refined into a detailed schedule.
- Here, specific development tasks (required to accomplish an activity) are identified and scheduled.

### EARNED VALUE ANALYSIS:

- It is reasonable to ask whether there is a quantitative technique for assessing progress as the software team progresses through the work tasks allocated to the project schedule.
- A Technique for performing quantitative analysis of progress does exist. It is called earned value analysis (EVA).
- To determine the earned value, the following steps are performed:
  1. The budgeted cost of work scheduled (BCWS) is determined for each work task represented in the schedule. During estimation, the work (in person-hours or person-days) of each software engineering task is planned. Hence,  $BCWS_i$  is the effort planned for work task  $i$ . To determine progress at a given point along the project schedule, the value of BCWS is the sum of the  $BCWS_i$  values for all work tasks that should have been completed by that point in time on the project schedule.
  2. The BCWS values for all work tasks are summed to derive the budget at completion (BAC). Hence,  $BAC = \sum BCWS_k$  for all tasks  $k$
  3. Next, the value for budgeted cost of work performed (BCWP) is computed. The value for BCWP is the sum of the BCWS values for all work tasks that have actually been completed by a point in time on the project schedule.
- Given values for BCWS, BAC, and BCWP, important progress indicators can be computed:

Schedule performance index,  $SPI = BCWP / BCWS$

Schedule variance,  $SV = BCWP - BCWS$

- SPI is an indication of the efficiency with which the project is utilizing scheduled resources. An SPI value close to 1.0 indicates efficient execution of the project schedule. SV is simply an absolute indication of variance from the planned schedule.
- Percent scheduled for completion =  $BCWS / BAC$
- provides an indication of the percentage of work that should have been completed by time  $t$ .
- Percent complete =  $BCWP / BAC$

provides a quantitative indication of the percent of completeness of the project at a given point in time  $t$ . It is also possible to compute the actual cost of work performed (ACWP). The value for ACWP is the sum of the effort actually expended on work tasks that have been completed by

a point in time on the project schedule. It is then possible to compute  
Cost performance index,  $CPI = BCWP / ACWP$   
Cost variance,  $CV = BCWP - ACWP$

A CPI value close to 1.0 provides a strong indication that the project is within its defined budget. CV is an absolute indication of cost savings (against planned costs) or shortfall at a particular stage of a project.

## **Process and Project Metrics:**

What are Metrics?

- Software process and project metrics are quantitative measures
- They are a management tool
- They offer insight into the effectiveness of the software process and the projects that are conducted using the process as a framework
- Basic quality and productivity data are collected
- These data are analyzed, compared against past averages, and assessed
- The goal is to determine whether quality and productivity improvements have occurred
- The data can also be used to pinpoint problem areas
- Remedies can then be developed and the software process can be improved

Reasons to Measure

- To characterize in order to
  - Gain an understanding of processes, products, resources, and environments
  - Establish baselines for comparisons with future assessments
- To evaluate in order to
  - Determine status with respect to plans
- To predict in order to
  - Gain understanding of relationships among processes and products
  - Build models of these relationships
- To improve in order to
  - Identify roadblocks, root causes, inefficiencies, and other opportunities for improving product quality and process performance

## **Metrics In The Process and Project Domains**

- *Process metrics are collected across all projects and over long periods of time.*
- Their intent is to provide a set of process indicators that lead to long-term software process improvement.

- *Project metrics enable a software project manager to*
- assess the status of an ongoing project,
- track potential risks,
- uncover problem areas before they go “critical,”
- adjust work flow or tasks,
- evaluate the project team’s ability to control quality of software work products

#### Process Metrics and Software Process Improvement:-

- Software process improvement, it is important to note that process is only one of a number of “controllable factors in improving software quality and organizational performance”.
- Process sits at the center of a triangle connecting three factors that have a profound influence on software quality and organizational performance.
- The skill and motivation of people has been shown to be the single most influential factor in quality and performance.
- The complexity of the product can have a substantial impact on quality and team performance.
- The technology (i.e., the software engineering methods and tools) that populates the process also has an impact.
- In addition, the process triangle exists within a circle of environmental conditions that include the development environment (e.g., integrated software tools), business conditions (e.g., deadlines, business rules), and customer characteristics (e.g., ease of communication and collaboration).

# Determinants for software quality and organizational effectiveness.

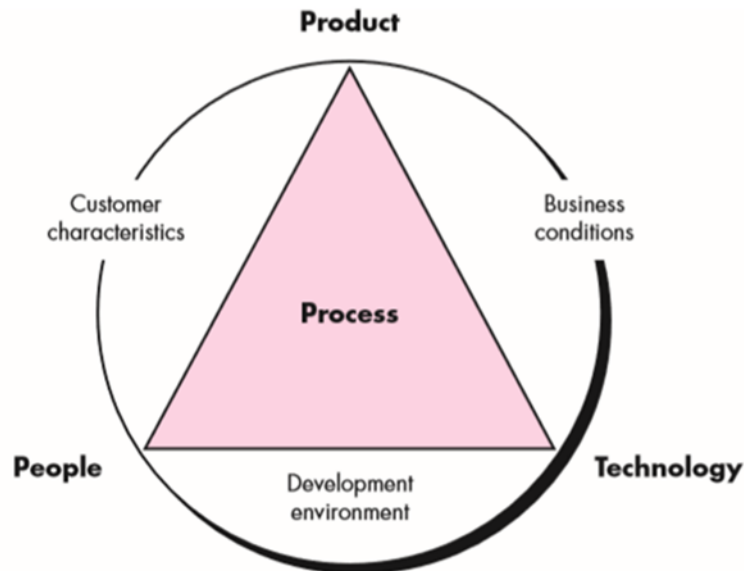

- Measure the effectiveness of a process by deriving a set of metrics based on outcomes of the process such as
  - Errors uncovered before release of the software
  - Defects delivered to and reported by the end users
  - Work products delivered
  - Human effort expended
  - Calendar time expended
  - Conformance to the schedule
  - Time and effort to complete each generic activity.
- Etiquette(good manners) of Process Metrics:
- Use common sense and organizational sensitivity when interpreting metrics data
- Provide regular feedback to the individuals and teams who collect measures and metrics
- Don't use metrics to evaluate individuals
- Work with practitioners and teams to set clear goals and metrics that will be used to achieve them

- Never use metrics to pressure individuals or teams
- Metrics data that indicate a problem should not be considered “negative

#### Project Metrics:-

- Many of the same metrics are used in both the process and project domain
- Project metrics are used for making tactical decisions
  - They are used to adapt project workflow and technical activities .
- The first application of project metrics occurs during estimation
  - Metrics from past projects are used as a basis for estimating time and effort
- As a project proceeds, the amount of time and effort expended are compared to original estimates.
- As technical work commences, other project metrics become important
  - Production rates are measured (represented in terms of models created, review hours, function points, and delivered source lines of code)
  - Error uncovered during each generic framework activity (i.e, communication, planning, modeling, construction, deployment) are measured.

#### SOFTWARE MEASUREMENT

- **Measurements in the physical world can be categorized in two ways: direct measures and indirect measures.**
- **Direct measures of the software process include cost and effort applied.**
- **Direct measures of the product include lines of code (LOC) produced, execution speed, memory size, and defects reported over some set period of time.**
- **Indirect measures of the product include functionality, quality, complexity, efficiency, reliability, maintainability.**
- **Project metrics can be consolidated to create process metrics for an organization.**

#### **1. Size-Oriented Metrics**

- **Size-oriented metrics are not universally accepted as the best way to measure the software process.**
- **Opponents argue that KLOC measurements**
  - **Are dependent on the programming language**
  - **Penalize well-designed but short programs**

- Cannot easily accommodate nonprocedural languages
- Require a level of detail that may be difficult to achieve.

## 2. **Function-Oriented Metrics:-**

- Function-oriented metrics use a measure of the functionality delivered by the application as a normalization value
- Most widely used metric of this type is the function point
- Computation of the function point is based on characteristics of the software's information domain and complexity.

### Function Point Controversy

- Like the KLOC measure, function point use also has proponents and opponents
- Proponents claim that
  - FP is programming language independent
  - FP is based on data that are more likely to be known in the early stages of a project, making it more attractive as an estimation approach
- Opponents claim that
  - FP requires some “sleight of hand” because the computation is based on subjective data
  - Counts of the information domain can be difficult to collect after the fact
  - FP has no direct physical meaning...it's just a number

## 3. **Reconciling LOC and FP Metrics:-**

- Relationship between LOC and FP depends upon
  - The programming language that is used to implement the software
  - The quality of the design
  - FP and LOC have been found to be relatively accurate predictors of software development effort and cost
  - However, a historical baseline of information must first be established.
- LOC and FP can be used to estimate object-oriented software projects
  - However, they do not provide enough granularity for the schedule and effort adjustments required in the iterations of an evolutionary or incremental process



- The table on the next slide provides a rough estimate of the average LOC to one FP in various programming languages.

Language	Average	Median	Low	High
Ada	154	--	104	205
Assembler	337	315	91	694
C	162	109	33	704
C++	66	53	29	178
COBOL	77	77	14	400
Java	55	53	9	214
PL/1	78	67	22	263
Visual Basic	47	42	16	158

#### 4. Object-oriented Metrics:-

Following set of metrics for OO projects:

**Number of scenario scripts:-** A scenario script is a detailed sequence of steps that describe the interaction between the user and the application.

- Each script is organized into triplets of the form

*{initiator, action, participant}*

- where initiator is the object that requests some service, *action is the result of the request, and participant is the server object that satisfies the request.*
- **Number of key classes:-** Key classes are the “highly independent components ” that are defined early in object-oriented analysis
- Because key classes are central to the problem domain, the number of such classes is an indication of the amount of effort required to develop the software.
- Also an indication of the potential amount of reuse to be applied during system development.

**Number of support classes:-** Support classes are required to implement the system but are not immediately related to the problem domain.

- The number of support classes is an indication of the amount of effort required to develop the software and also an indication of the potential amount of reuse to be applied during system development.
- Number of subsystems
  - A subsystem is an aggregation of classes that support a function that is visible to the end user of a system.

**Average number of support classes per key class**

- Key classes are identified early in a project (e.g., at requirements analysis)
- Estimation of the number of support classes can be made from the number of key classes
- GUI applications have between two and three times more support classes as key classes
- Non-GUI applications have between one and two times more support classes as key classes

## **5. Use-Case–Oriented Metrics:-**

- Use cases describe user-visible functions and features that are basic requirements for a system.
- The number of use cases is directly proportional to the size of the application in LOC and to the number of test cases that will have to be designed to fully exercise the application.

## **6. WebApp Project Metrics:-**

- The objective of all WebApp projects is to deliver a combination of content and functionality to the end user.
- The measures that can be collected are:
  - Number of static Web pages.
  - Number of dynamic Web pages.
  - Number of internal page links:-Internal page links are pointers that provide a hyperlink to some other Web page within the WebApp.

## Number of persistent dataobjects.

- Number of external systems interfaced:- WebApps must often interface with “backroom” business applications.
- Number of static content objects:-Static content objects encompass static text-based, graphical, video, animation, and audio information that are incorporated within the WebApp.
- Number of dynamic contentobjects.
- Number of executable functions

$N_{sp}$  = number of Static Web pages  
 $N_{dp}$  = number of Dynamic Web pages

Then,

$$\text{Customization index, } C = \frac{N_{dp}}{N_{dp} + N_{sp}}$$

The value of C ranges from 0 to 1. As C grows larger, the level of WebApp customization becomes a significant technical issue.

## METRICS FOR SOFTWARE QUALITY:

- The overriding goal of software engineering is to produce a high-quality system, application, or product within a time frame that satisfies a market need.
- The quality of a system, application, or product is only as good as the requirements that describe the problem, the design that models the solution, the code that leads to an executable program, and the tests that exercise the software to uncover errors.

### Measuring Quality

- There are many measures of software quality,8 correctness, maintainability, integrity, and usability provide useful indicators for the project team

### Correctness:

- Correctness is the degree to which the software performs its required function.
- The most common measure for correctness is defects per KLOC, where a defect is defined as a verified lack of conformance to requirements.
- Defects are those problems reported by a user of the program after the program has been released for general use.

### Maintainability:

- Maintainability is the ease with which a program can be corrected if an error is encountered, adapted if its environment changes, or enhanced if the customer desires a change in requirements.

- *Mean -time-to-change (MTTC), the time it takes to analyze the change request, design an appropriate modification, implement the change, test it, and distribute the change to all users.*

#### Integrity:

- Software integrity has become increasingly important in the age of cyber terrorists and hackers.
- Attacks can be made on all three components of software: programs, data, and documentation.
- To measure integrity, two attributes must be defined:
  - threat and security.

#### Usability:

- If a program is not easy to use, it is often doomed to failure, even if the functions that it performs are valuable

#### Defect Removal Efficiency:

- Defect removal efficiency provides benefits at both the project and process level
- It is a measure of the filtering ability of quality assurance activities as they are applied throughout all process framework activities
  - It indicates the percentage of software errors found before software release
- It is defined as  $DRE = E / (E + D)$ 
  - E is the number of errors found before delivery of the software to the end user
  - D is the number of defects found after delivery
- As D increases, DRE decreases (i.e., becomes a smaller and smaller fraction)
- The ideal value of DRE is 1, which means no defects are found after delivery
- DRE encourages a software team to institute techniques for finding as many errors as possible before delivery.

#### METRICS FOR SMALL ORGANIZATIONS

- Most software organizations have fewer than 20 software engineers.
- It is reasonable to suggest that software organizations of all sizes measure and then use the resultant metrics to help improve their local software process and the quality and timeliness of the products they produce.
- A commonsense approach to the implementation of any software process-related activity is: keep it simple, customize to meet local needs, and be sure it adds value.

A small organization might select the following set of easily collected measures:

- Time (hours or days) elapsed from the time a request is made until evaluation is complete, *tqueue*.
- Effort (person-hours) to perform the evaluation, *Weval*.
- Time (hours or days) elapsed from completion of evaluation to assignment of change order to personnel, *teval*.

### Integrating Metrics Within The Software Process

Arguments for Software Metrics:-

- Most software developers do not measure, and most have little desire to begin
- Establishing a successful company-wide software metrics program can be a multi-year effort
- But if we do not measure, there is no real way of determining whether we are improving
- Measurement is used to establish a process baseline from which improvements can be assessed
- Software metrics help people to develop better project estimates, produce higher-quality systems, and get products out the door on time.
- The collection of quality metrics enables an organization to “tune” its software process to remove the “vital few” causes of defects that have the greatest impact on software development.

Establishing a Baseline:-

- By establishing a metrics baseline, benefits can be obtained at the software process, product, and project levels
- The same metrics can serve many masters
- The baseline consists of data collected from past software development projects.
- **Baseline data must have the following attributes**
  - Data must be reasonably accurate (guesses should be avoided)
  - Data should be collected for as many projects as possible
  - Measures must be consistent (e.g., a line of code must be interpreted consistently across all projects)
  - Past applications should be similar to the work that is to be estimated.

### Metrics Collection, Computation, and Evaluation

- Data collection requires an historical investigation of past projects to reconstruct required data
- After data is collected and metrics are computed, the metrics should be evaluated and applied during estimation, technical work, project control, and process improvement.

### **Establishing a software metrics program:**

- The Software Engineering Institute has developed a comprehensive guidebook for establishing a “goal-driven” software metrics program.

The guidebook suggests the following steps:

- Identify business goal
- Identify what you want to know
- Identify subgoals
- Identify subgoal entities and attributes
- Formalize measurement goals
- Identify quantifiable questions and indicators related to subgoals
- Identify data elements needed to be collected to construct the indicators
- Define measures to be used and create operational definitions for them
- Identify actions needed to implement the measures
- Prepare a plan to implement the measures

For example, consider the SafeHome product. Working as a team, software engineering and business managers develop a list of prioritized business goals:

1. Improve our customers’ satisfaction with our products.
2. Make our products easier to use.
3. Reduce the time it takes us to get a new product to market.
4. Make support for our products easier.
5. Improve our overall profitability.